

EURAMET Pilot Study 1506: Validation of standards for liquid flow rate under dynamic flows

Florestan OGHEARD, CETIAT, head of French primary standard laboratory for Liquid Flow

florestan.ogheard@cetiat.fr



Metrology for Real-World
Domestic Water Metering



The EMPIR initiative is co-funded by the European Union's Horizon 2020 research and innovation programme and the EMPIR Participating States

Outline

- **Introduction**
- **Pilot study details: partners, profiles, transfer standard,...**
- **Results**
- **Analysis**
- **Conclusion**

Outline

➤ Introduction

EURAMET 1506 Pilot Study - Introduction

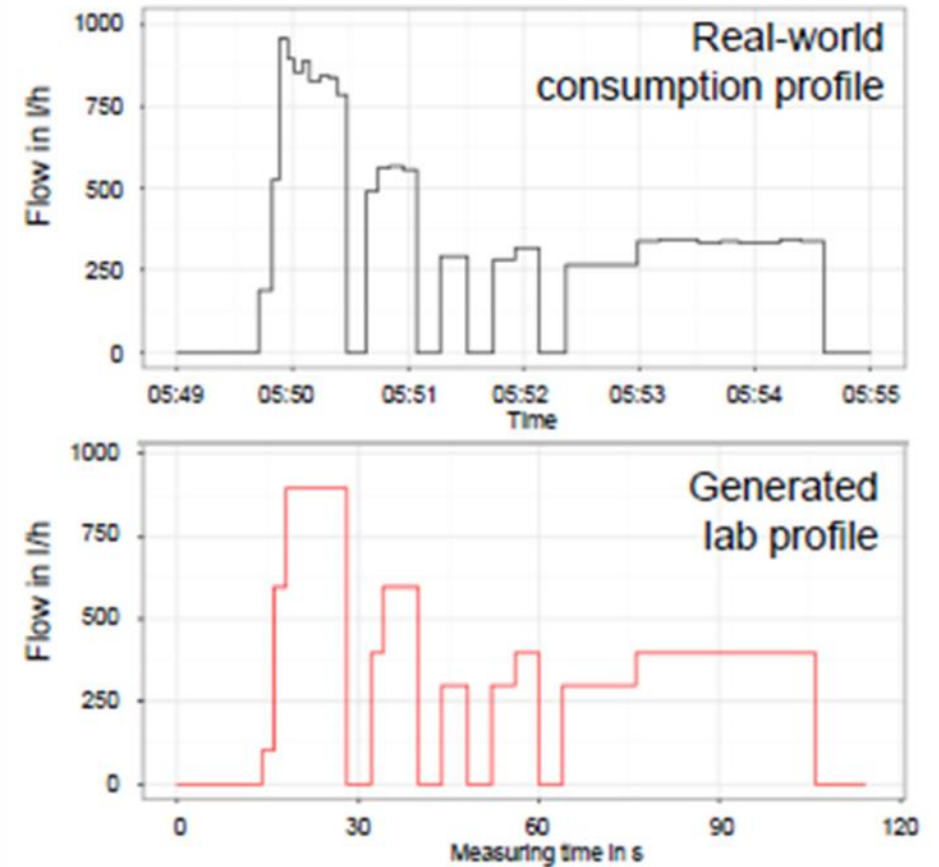
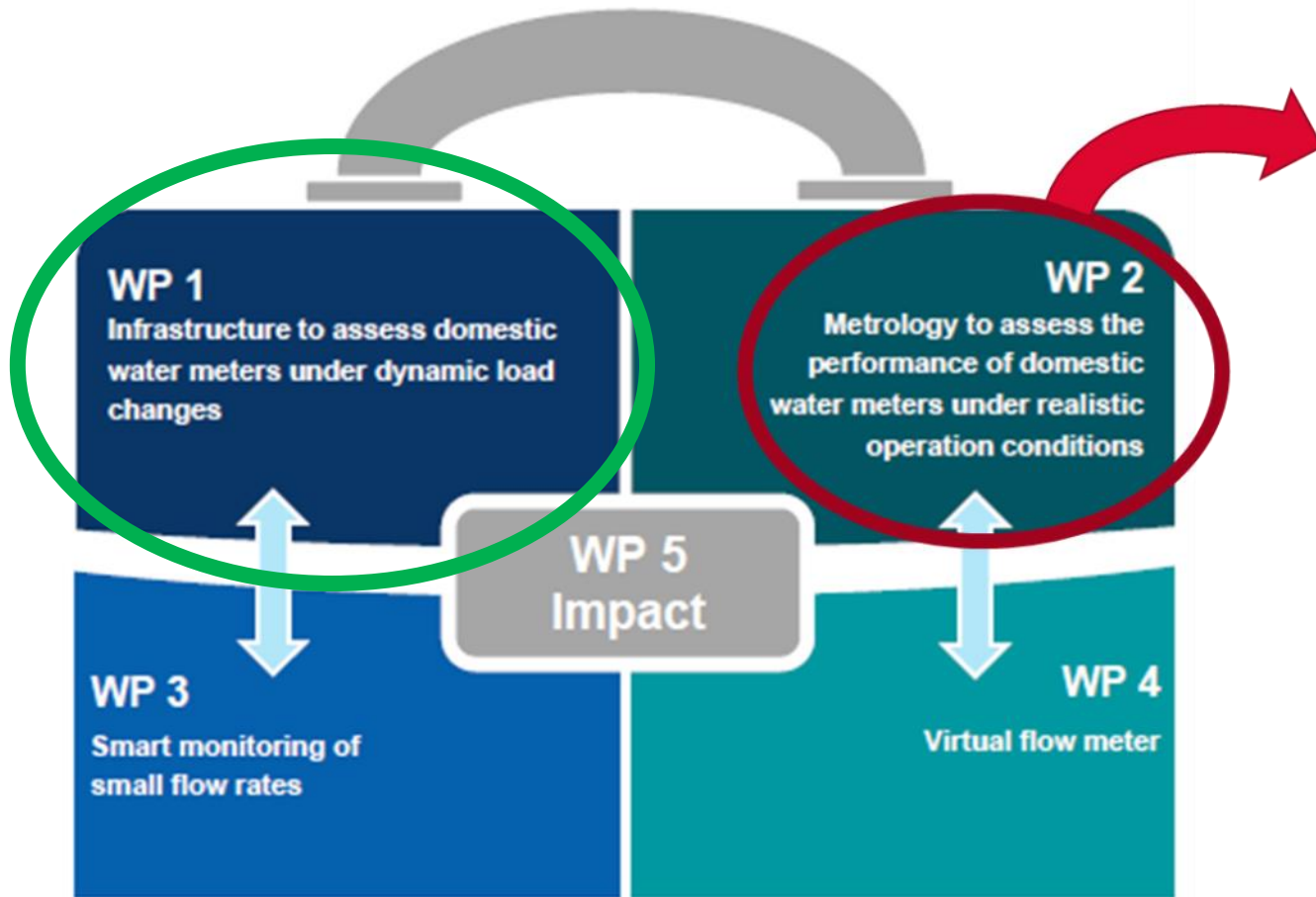

EURAMET 1506 Pilot Study - Introduction

C1.c Task 1.3: Evaluation of test rigs operated with dynamic load changes

The aim of this task is to evaluate and optimise the test rigs developed in Task 1.2 as well as those already under development by partners outside the project by inter-comparisons. This includes a rigorous uncertainty assessment. The rigs must meet at minimum the specifications of OIML R49 (Section 4 "Metrology") for the different applications for water meters given there (see specifications in WP1 introduction). A diagnostic comparison will be carried out directly after the test rigs have been realised. Based on the findings the rigs will be optimised and further improved for practical operation. Subsequently, a second comparison will be carried out for a final evaluation of the test rigs. For the inter-comparisons, Coriolis meters in total covering the range 1 L/h – 5000 L/h will be deployed and amongst others the reference consumption profile(s) from Task 1.1 used.

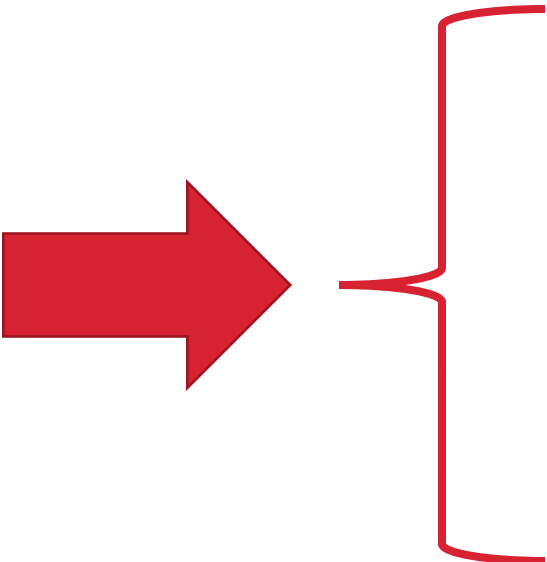

Activity number	Activity description	Partners (Lead in bold)
A1.3.1 M23	PTB will prepare the necessary protocols, plans etc. to carry out an inter-comparison of the test rigs for dynamic load changes set up in A1.2.3.	PTB
A1.3.2 M29	PTB together with CETIAT, CMI, DTI, RISE, VTT, FORCE and TUBITAK will carry out an inter-comparison of their test rigs for dynamic load changes using the test profile of A1.1.4 (it will be provided in March 2020 (M22)) and Coriolis meters (the number of those will depend also on the test profile of A1.1.4). The partners will evaluate the results. This activity will provide information about the repeatability of the test rigs with highly accurate meters (Coriolis meters).	PTB, CETIAT, CMI, DTI, RISE, VTT, FORCE, TUBITAK
A1.3.3 M31	Based on the results of A1.3.2 PTB together with CETIAT, CMI, VTT, DTI, RISE, FORCE and TUBITAK will optimise their test rigs where necessary (in an ideal case, 8 test rigs in total, i.e. one per partner). Inter-comparisons with only a few partners will be carried out to reassess the optimised test rigs.	PTB, CETIAT, CMI, DTI, RISE, VTT, FORCE, TUBITAK
A1.3.4 M34	PTB together with CETIAT, VTT, CMI, DTI, RISE, FORCE and TUBITAK will re-evaluate the measurement uncertainty of their test rigs in case of modifications according to A1.3.3.	PTB, CETIAT, CMI, DTI, RISE, VTT, FORCE, TUBITAK

Outline

- **Pilot study details: partners, profiles, transfer standard,...**

EURAMET 1506 Pilot Study: details

➤ **GOAL : validation of dynamic liquid flow primary standards developed in the scope of JRP METROWAMET (2018-2021)**

- **Inter-laboratory comparison**
- **3 Different dynamic flow profiles with different start and stop conditions (flying start, standing start, etc.)**
- **Different total volumes (50, 100, 80 L)**

N°1, 50 L		N°2, 100 L		N°3, 80 L	
Measuring time [s]	Volume flow [l/h]	Measuring time [s]	Volume flow [l/h]	Measuring time [s]	Volume flow [l/h]
0	193	0	1638	0	0
42	501	10.481	655.2	30	133.2
54	580	39.662	345.6	42.673	1400.4
82	1570	106.584	302.4	75.298	478.8
94	645	126.459	248.4	96.197	313.2
105	410	138.97	568.8	108.364	194.4
123	387	160.698	363.6	129.474	496.8
141	372	173.542	464.4	150.319	1328.4
160	258	187.18	338.4	166.648	561.6
179	0	294.21	334.8	208.84	493.2
209	425	348.642	756	221.344	878.4
304	269	398.457	0	263.201	619.2
319	307	428.457	381.6	292.573	230.4
330	451	443.699	626.4	313.311	126
423	645	482.067	622.8	326.245	406.8
443	645	504.031	327.6	348.129	140.4
		514.688	374.4	360.654	7.2
		534.509	658.8	395.113	396
		547.976	540	413.505	367.2
		568.824	482.4	431.225	464.4
		590.919	532.8	444.863	540
		611.527	615.6	465.711	622.8
		632.655	550.8	487.675	1155.6
		661.237	511.2	512.853	612
		688.411	669.6	530.147	565.2
		718.215	525.6	559.52	565.2

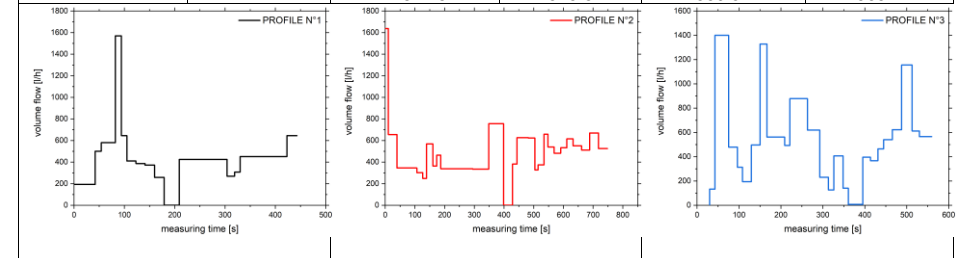

EURAMET 1506 Pilot Study: details

- 8 partners (NMIs and DIs)
- From September 2020 to June 2021
- Different test rigs technologies and methods
- Transfer standard's drift during pilot study and zero drift has been evaluated by pilot laboratory

	Institute	Country	Test rig, method of measurement	Flow profile measured (No.)	Flow change (s)	Flow change technology
1	CETIAT (PILOT)	France	Gravimetric with weighing system See annex A and references: [3, 4]	1, 2, 3	< 1	Fast valves
2	PTB	Germany	Gravimetric with weighing system See annex B and reference [5]	1, 2, 3	<0.1	Critical Nozzles
3	FORCE	Denmark	Gravimetric with weighing system See annex C	2		Fast valves
4	CMI	Czech Republic	Volumetric with piston prover See annex D	1, 2, 3	<0.32	Fast piston position changes
5	RISE	Sweden	Volumetric with piston prover plus integrated measuring system (IMS) See reference: [6]	1, 2, 3	< 0.1	12-bit digital valves (pneumatically controlled modular on-off bits of binary sized flow resistors)
6	DTI	Denmark	Gravimetric with weighing system See annex E and reference [7]	1, 2, 3		Fast valves
7	VTT	Finland	Gravimetric with weighing system See annex F	1, 2, 3		Fast valves
8	UME TUBITAK	Turkey	Reference flow meter See annex G	1		Fast valves

EURAMET 1506 Pilot Study: details

Reminder: Gravimetric vs. Volumetric methods:



THEENGINEERINGMINDSET.COM



THEENGINEERINGMINDSET.COM

EURAMET 1506 Pilot Study: details

CALIBRATION METHODS FOR LIQUID FLOW METERS	GRAVIMETRIC (weighing system)	VOLUMETRIC (scaled tank, provers)
STATIC (Flying start-and-stop)	Static weighing + diverter	Scaled tank + diverter, provers
STATIC (Standing start-and stop)	Static weighing	Scaled tank, provers
DYNAMIC	ISO Definition	Dynamic level gauging, Dynamic piston provers, ...
	Dynamic weighing	

EURAMET 1506 Pilot Study: details

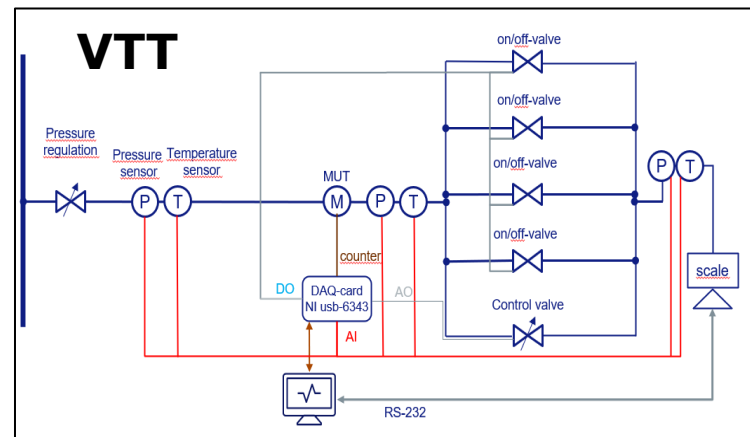
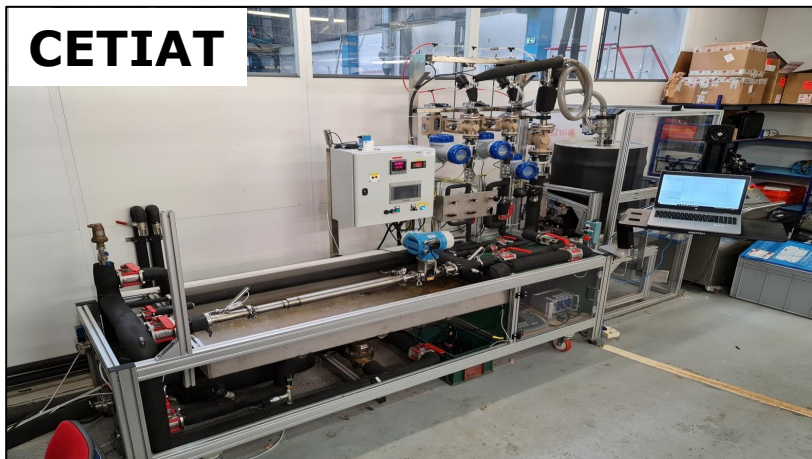
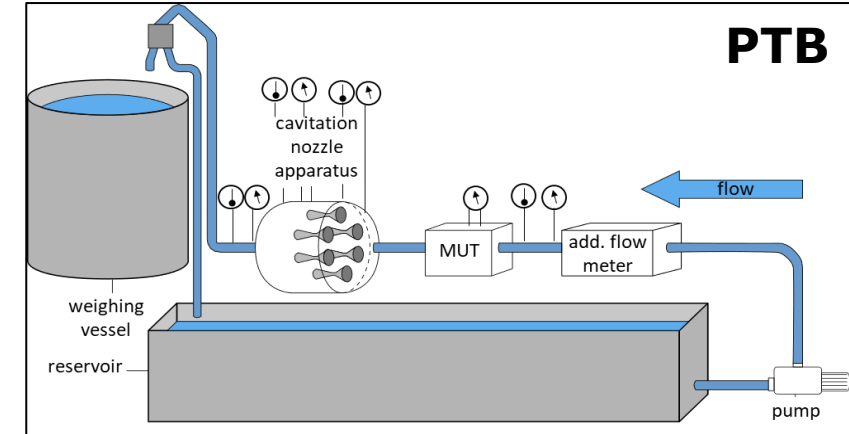
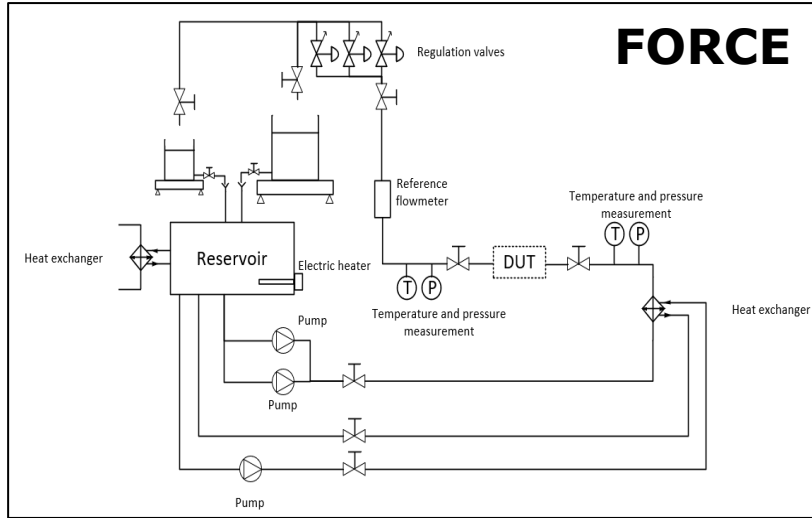

EURAMET 1506 Pilot Study: details

EXAMPLE OF CETIAT'S DYNAMIC PRIMARY STANDARD CALIBRATION PROCESS:

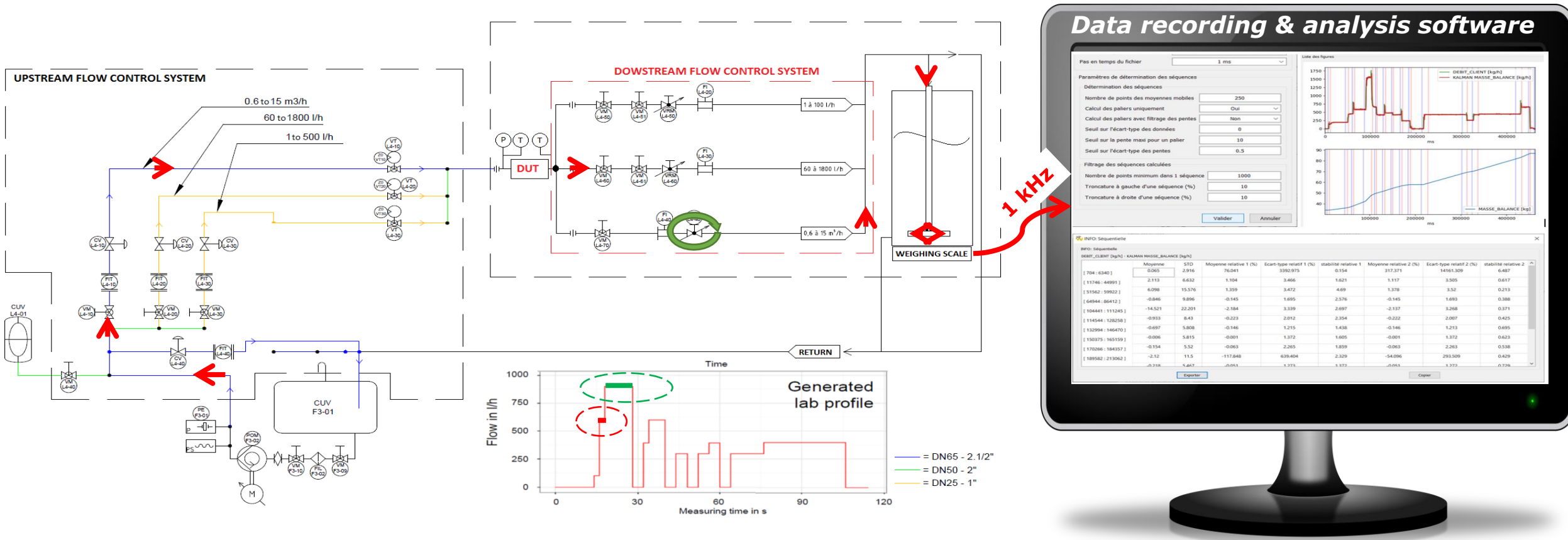

EURAMET 1506 Pilot Study: details

EXEMPLE OF CETIAT'S DYNAMIC PRIMARY STANDARD CALIBRATION PROCESS:

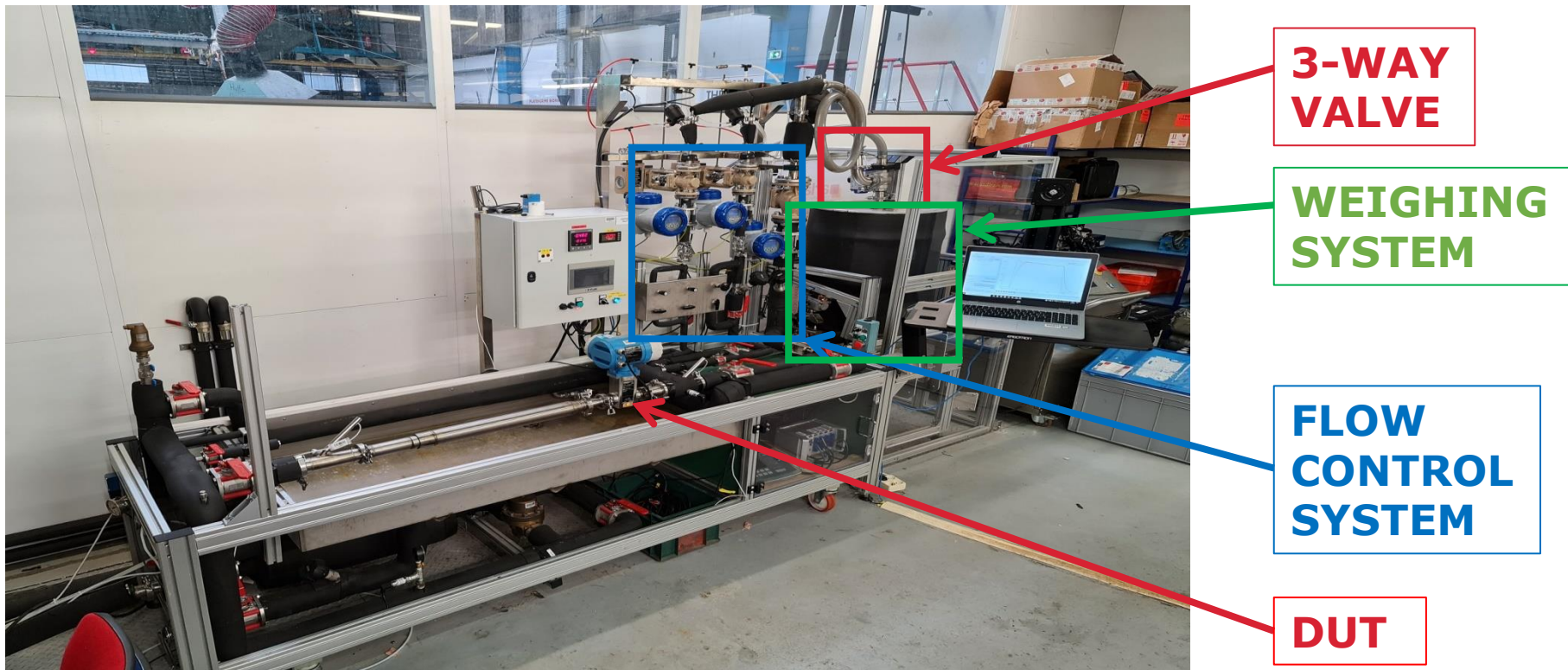

EURAMET 1506 Pilot Study: details

TRANSFER STANDARD (VALIDATION MODULE):

- Emerson MicroMotion Elite CMFS040M Coriolis Mass Flow meter
- Outputs: Pulse (1 g/pulse), 4-20 mA, Digital (flow, T°, Pressure)
- Dedicated 40 ms sampling electronics with recording software

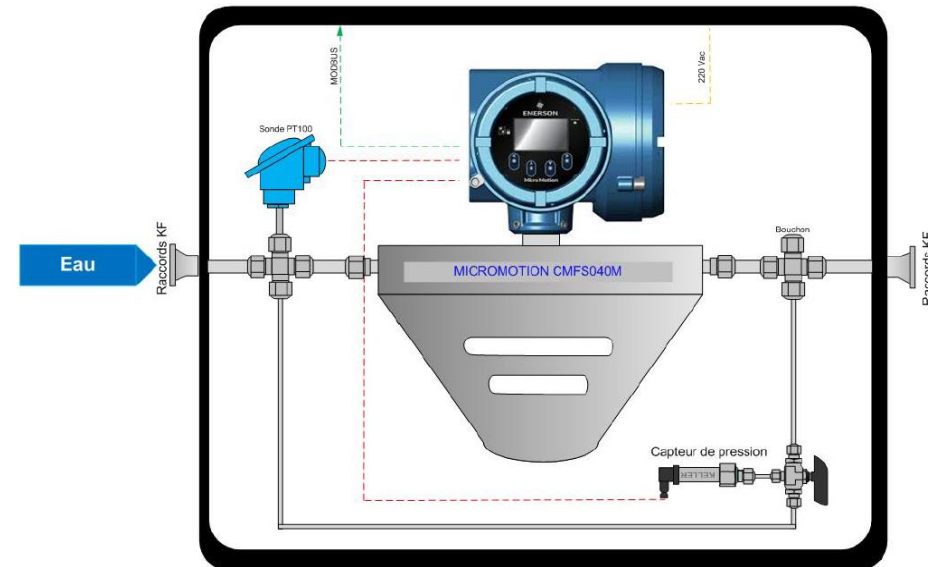
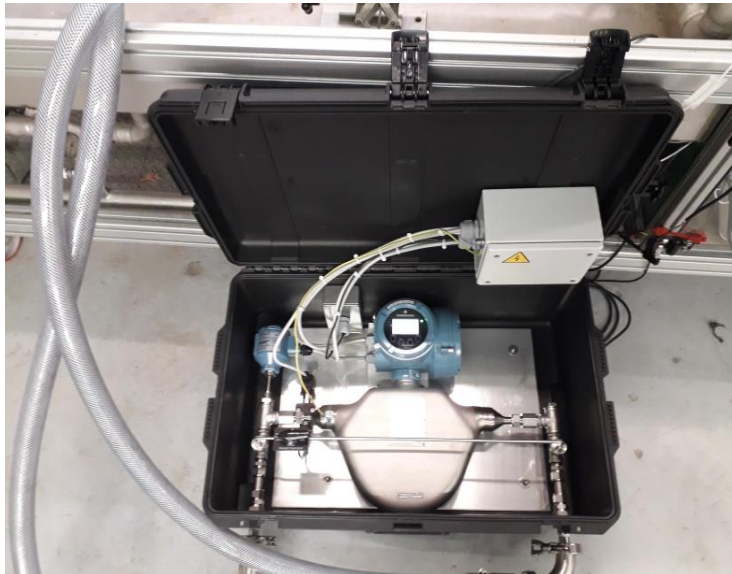

EURAMET 1506 Pilot Study: details

DYNAMIC FLOW PROFILES:

- Flow profile No. 1: starts with a **medium** flow rate and ends with a **medium** flow rate
- Flow profile No. 2: starts with a **high** flow rate and ends with a **medium** flow rate
- Flow profile No. 3: starts with a **zero** flow rate and ends with a **medium** flow rate.

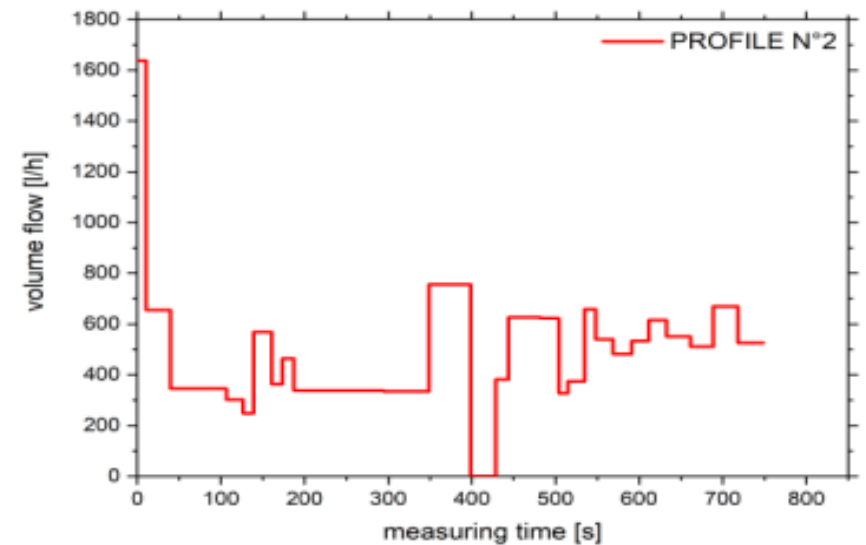
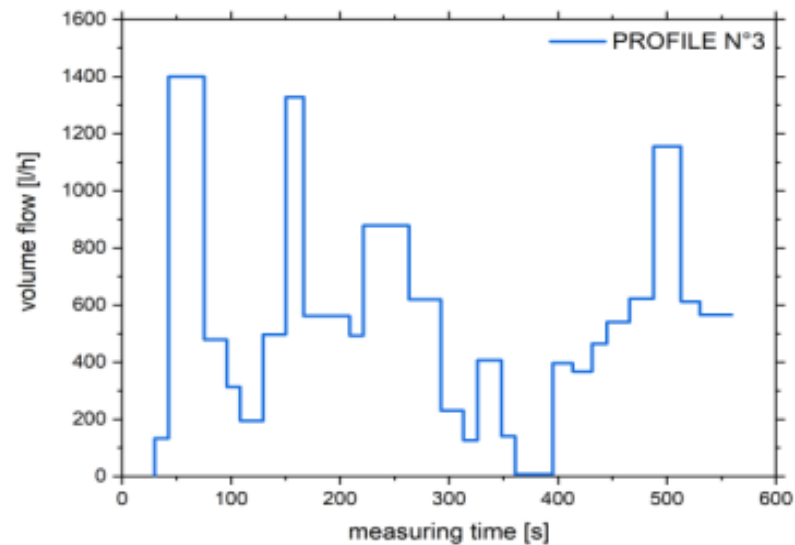
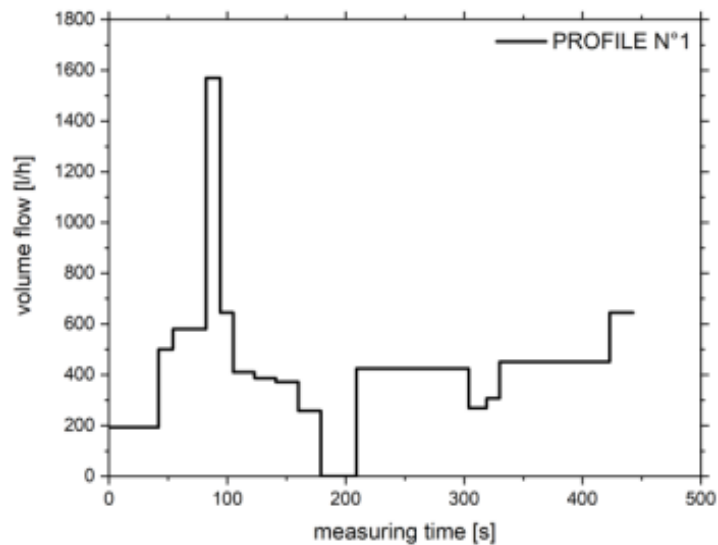

Outline

➤ **Results**

EURAMET 1506 Pilot Study: results

RESULTS:



		CETIAT		PTB		FORCE		CMI		UME TUBITAK		RISE		DTI		VTT	
		U(k=2)	En	U(k=2)	En	U(k=2)	En	U(k=2)	En	U(k=2)	En	U(k=2)	En	U(k=2)	En	U(k=2)	En
PROFILE	1	0.20 %	0.51	0.10 %	1.04			0.16 %	0.03	0.33 %	0.04	0.10 %	0.42	0.11 %	0.29	0.40 %	0.23
	2	0.10 %	0.19	0.10 %	0.93	0.10 %	0.06	0.22 %	0.18			0.10 %	0.50			0.28 %	0.23
	3	0.18 %	0.42	0.10 %	0.10			0.16 %	0.38			0.10 %	0.45	0.15 %	0.04	0.28 %	0.46



EURAMET 1506 Pilot Study: results

RESULTS:

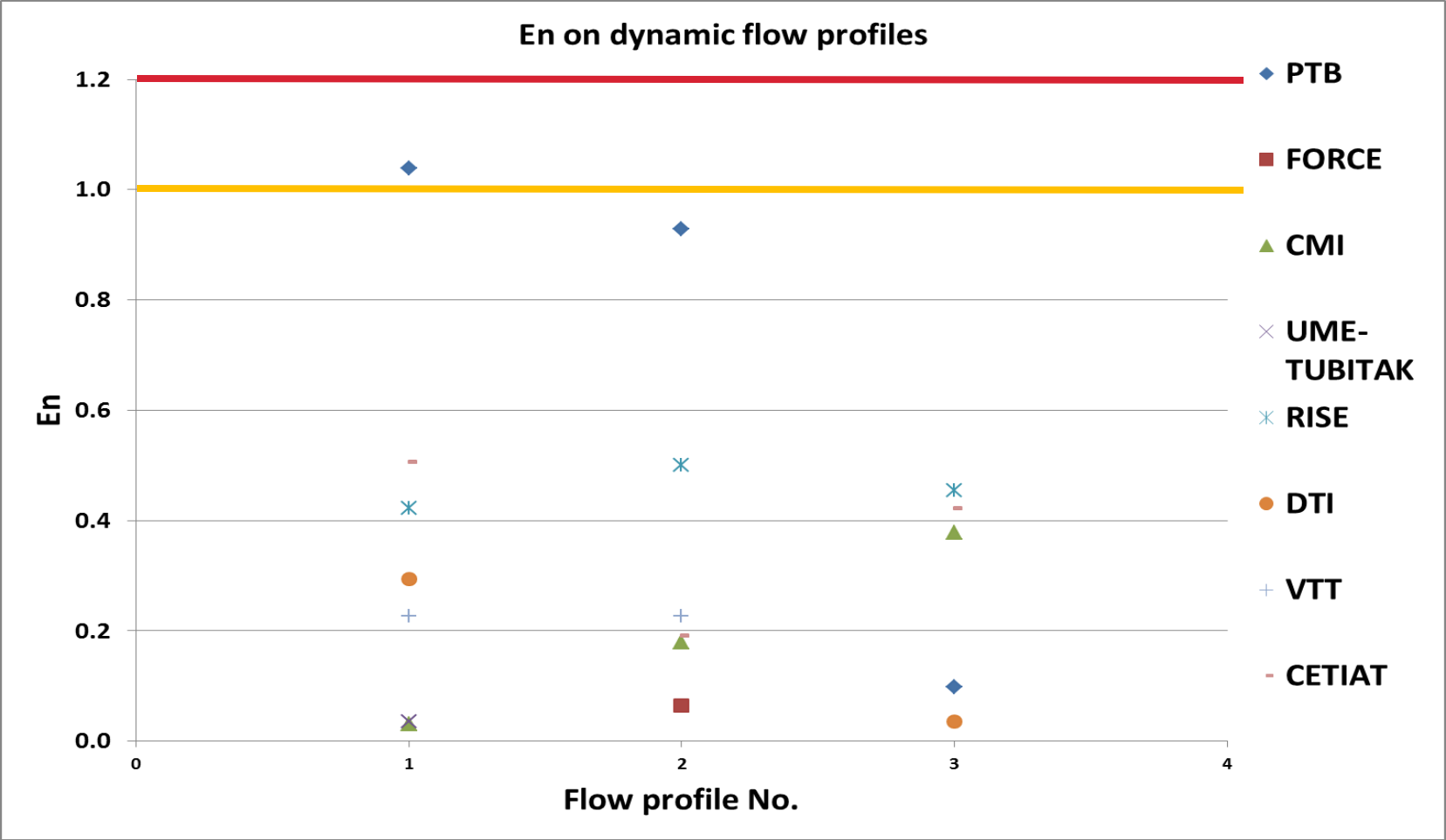

EURAMET 1506 Pilot Study: results

RESULTS:

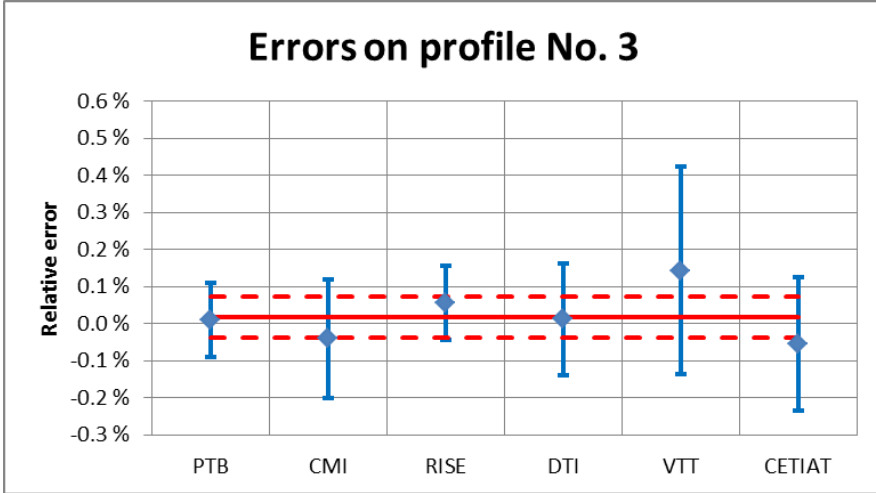
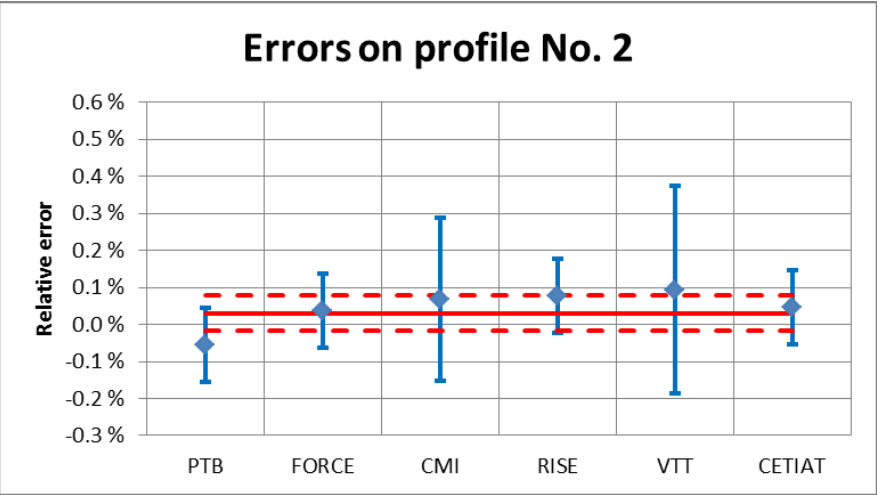
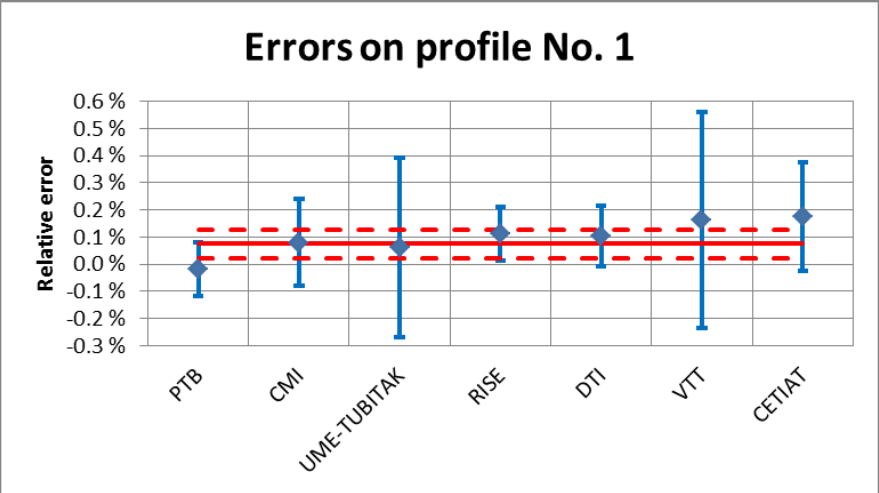

Outline

➤ Analysis

EURAMET 1506 Pilot Study: analysis

FLOW CHANGE CHARACTERISTICS (ANALYSIS BY PTB):

increasing flow change characteristic

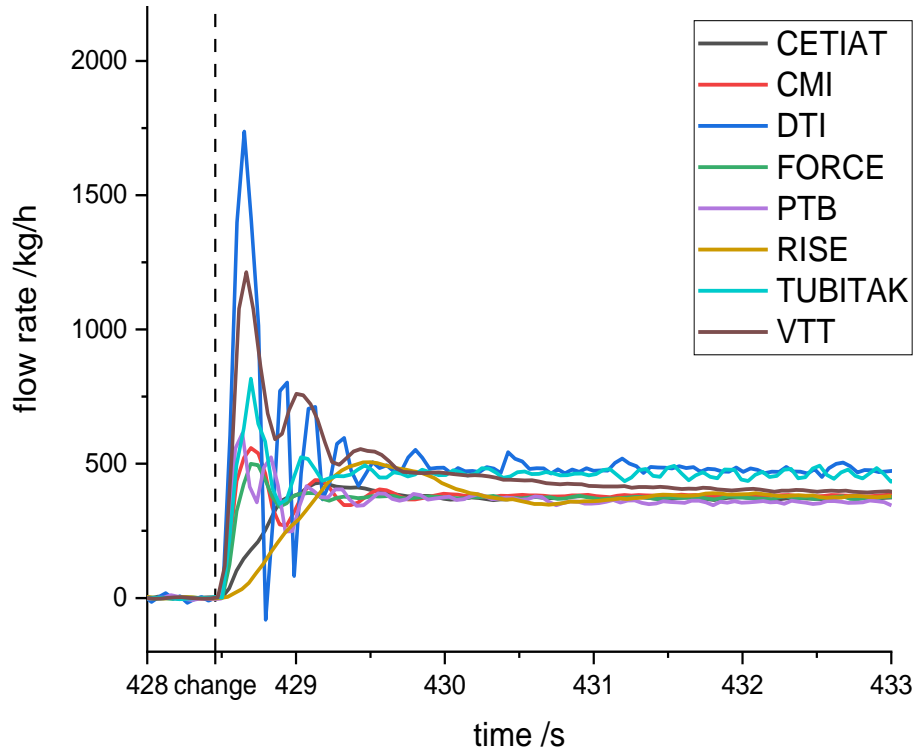

decreasing flow change characteristic

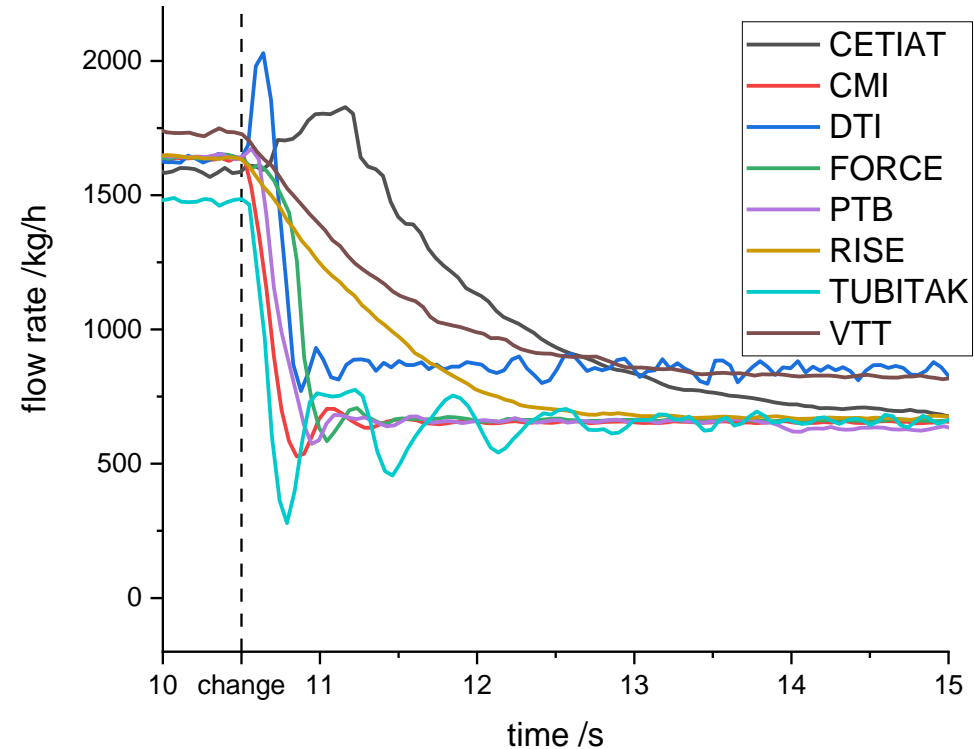

NMI	Flow change duration	
	decreasing [s]	increasing [s]
CETIAT	4.53	0.79
CMI	0.36	0.27
DTI	0.60	0.17
FORCE	0.65	0.22
PTB	0.36	0.17
RISE	2.91	0.84
UME	0.27	0.36
VTT	3.91	0.17

EURAMET 1506 Pilot Study: analysis

FLOW CHANGE CHARACTERISTICS (ANALYSIS BY PTB):

Institut	profile no.	repeatability	mean of residuals	deviation total mass
		kg/h	kg/h	%
CETIAT	1	6.70	10.82	2.81
CETIAT	2	4.65	-54.56	-10.79
CETIAT	3	4.60	3.81	1.05
CMI	1	4.73	-10.71	4.75
CMI	2	8.04	-5.07	4.93
CMI	3	11.52	4.89	5.63
DTI	1	63.63	152.32	37.96
DTI	2	41.99	131.56	28.72
DTI	3	47.95	146.48	27.79
FORCE	2	6.95	10.23	2.55
PTB	1	7.66	6.44	1.89
PTB	2	7.68	-5.22	-0.34
PTB	3	8.98	5.57	1.32
RISE	1	4.79	2.22	1.67
RISE	2	5.42	1.46	1.46
RISE	3	6.37	5.40	2.10
TUBITAK	1	13.34	15.77	3.43
VTT	1	19.38	-36.87	-8.79
VTT	2	4.19	-9.37	-1.94
VTT	3	3.21	10.49	1.83

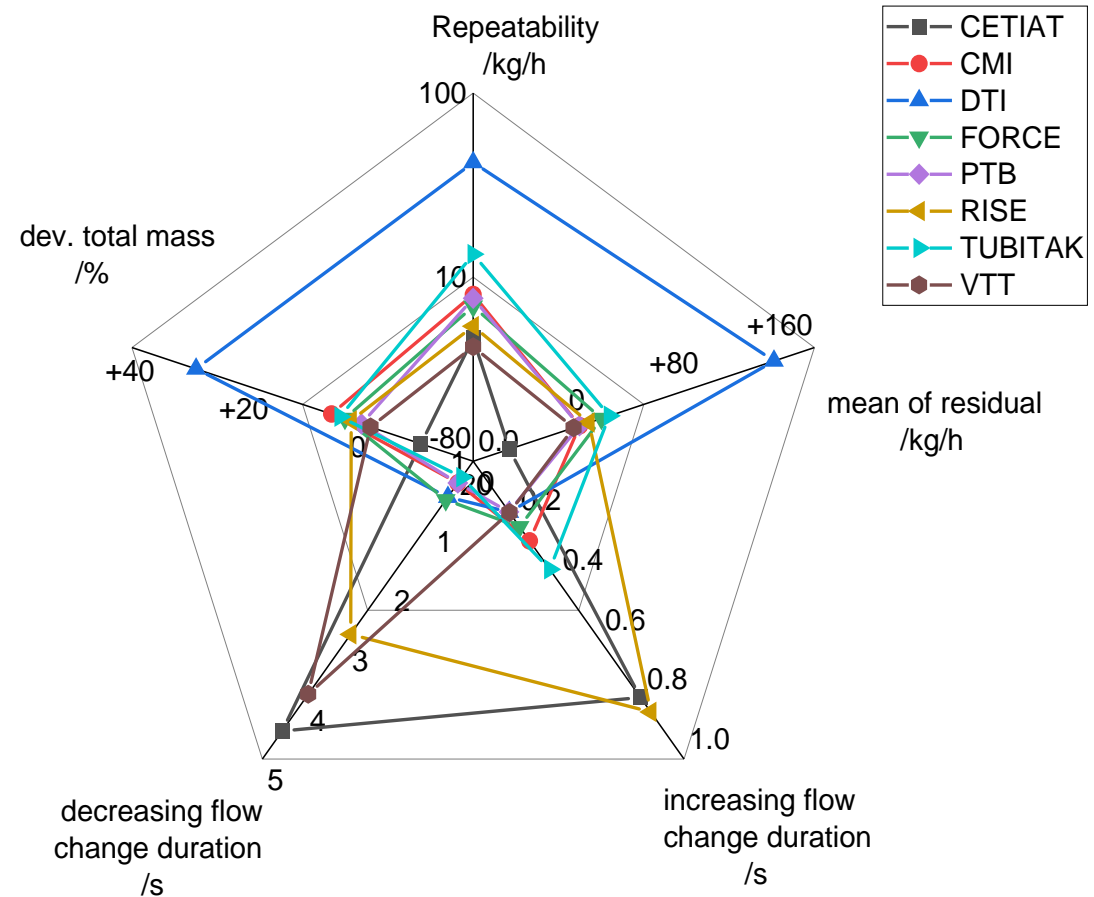

EURAMET 1506 Pilot Study analysis

FLOW CHANGE CHARACTERISTICS (ANALYSIS BY PTB):

- The analysis includes, for all partners:
 - First row: continuous recorded (20 Hz) mass flow signal of the Coriolis from n profile repetitions;
 - 2nd and 3rd row: Residuals of the averaged flow profile, plotted versus time and plotted versus flow rate;
 - 4th row: frequency distribution of the residuals

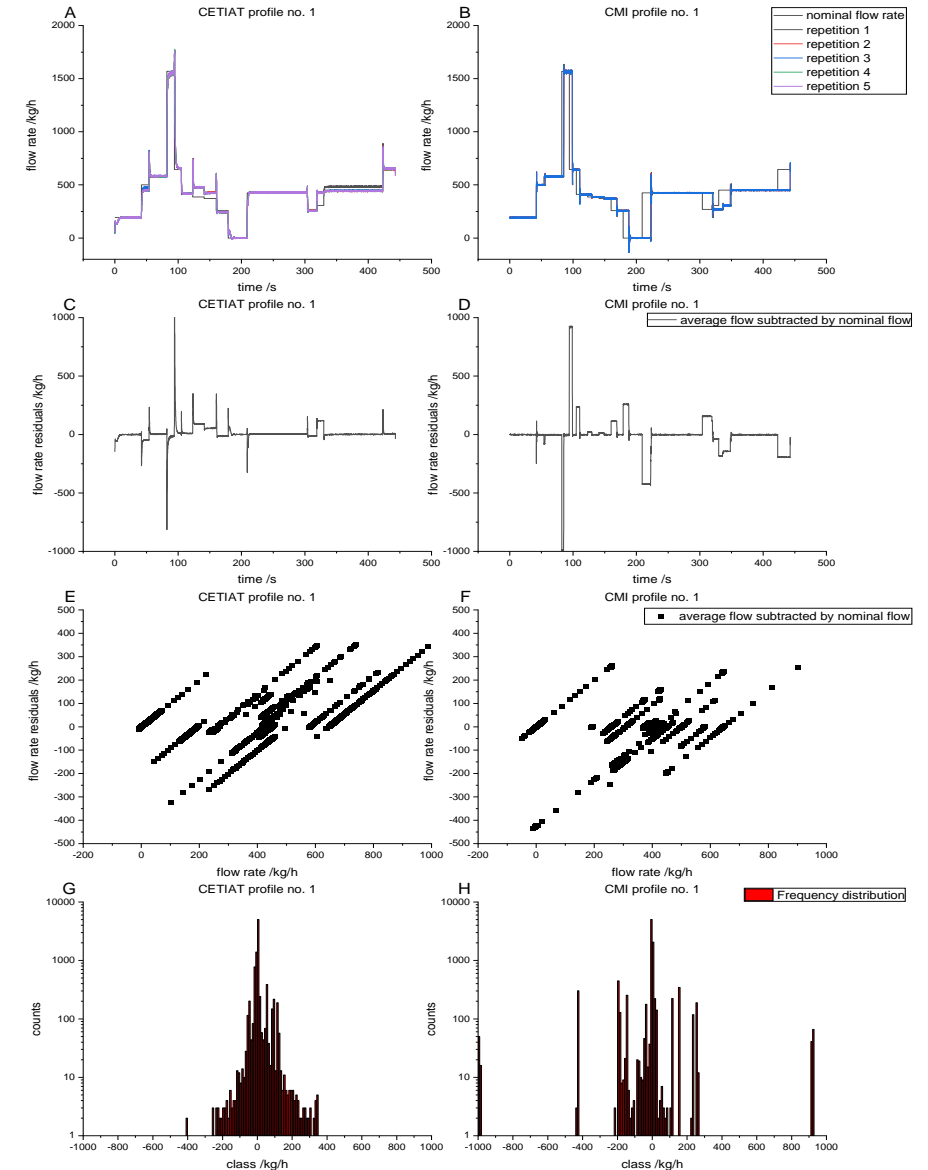

Outline

➤ **Conclusion**

Conclusion

- This unprecedented ILC gives an overview of the CMCs of 8 NMIs and DIs for **dynamic liquid flows**. Three test flow profiles with different total volumes comprising rapid flow changes in a flow rate range from 7 kg/h to 1600 kg/h and steps durations down to 10 s have been used for these investigations. Moreover, the flow profiles differed distinctively in their initial and final conditions.
- The **degrees of equivalence** (DoE) observed in this inter-comparison show that the test facilities for dynamic liquid flow calibrations of the participating laboratories **are in very good agreement**.
- The participating laboratories state **expanded measurement uncertainties** of their test facilities between **0.1 % and 0.4 % ($k=2$)**.
- The report includes descriptions of all dynamic test rigs, in-depth data analysis of flow change and measurements capabilities.



Domaine scientifique de la Doua
25 avenue des Arts – BP 52042
69603 VILLEURBANNE CEDEX - FRANCE

Mail : information@cetiat.fr

Tél : 04 72 44 49 00

Fax : 04 72 44 49 49

Florestan OGHEARD

Head of French primary standard laboratory for Liquid Flow

florestan.ogheard@cetiat.fr

www.cetiat.fr

