



Metrology for Real-World
Domestic Water Metering

Performance of domestic water meters under static and dynamic test conditions - first insights

Oliver Büker, RISE



Introduction

- Flow meters are often calibrated only at some “stable” (constant) flow rates but this calibration does not necessarily reflect the later real world application.
- In the frame work of the project (WP1) consumption profiles from all parts of Europe (north, centre, south) were analysed and three reference profiles for different volume were derived from the obtained data. => **Presentation Daniel Schumann, PTB**
- Test facilities were developed by the partners in order to perform measurements with the three reference profiles. => **Presentation Florestan Ogheard, CETIAT**
- Different domestic water meter types (representative for each country) were tested under static and dynamic conditions during the project.



Implementation

- 7 project partners (CMI, PTB, DTI, VTT, TÜBİTAK UME, FORCE, and RISE) with a test facility available for dynamic measurements have performed measurements with commercial in-use domestic water meters as found in the EU market for their performance under dynamic load changes.
- The tests include measurements for static flow conditions for reference (baseline). The measurements were carried out according to OIML R-49 regarding boundary conditions and flow points:
 1. Flow point: Q1 to 1.1 Q1
 2. Flow point: Q2 to 1.1 Q2
 3. Flow point: $0.33 \times (Q2 + Q3)$ to $0.37 \times (Q2 + Q3)$
 4. Flow point: $0.67 \times (Q2 + Q3)$ to $0.74 \times (Q2 + Q3)$
 5. Flow point: 0.9 Q3 to Q3
 6. Flow point: 0.95 Q4 to Q4



Measurement results (CMI)

CMI (Czech metrology institute)

- Number of meter types: 4 (Meter A – D)
- Quantity per meter type: 3 (= 12 pcs total)
- 3 dynamic profiles each
- Pulse output, flying start-and-stop



Static performance

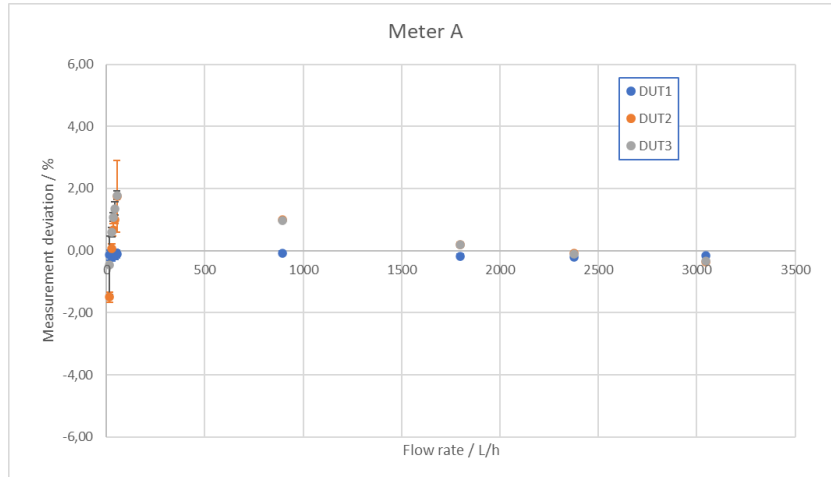

Dynamic performance

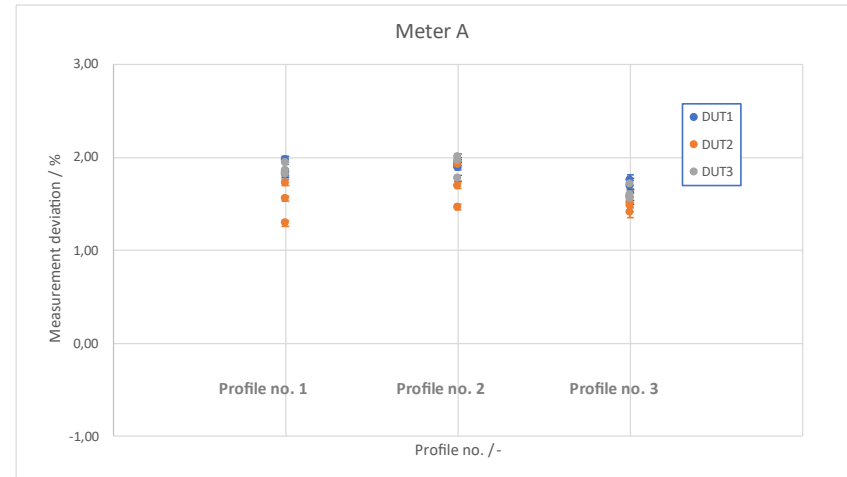

Meter A: Piston water meter DN 15, Q3 2.5 R400



Measurement results (CMI)

CMI (Czech metrology institute)

- Number of meter types: 4 (Meter A – D)
- Quantity per meter type: 3 (= 12 pcs total)
- 3 dynamic profiles each
- Pulse output, flying start-and-stop



Static performance

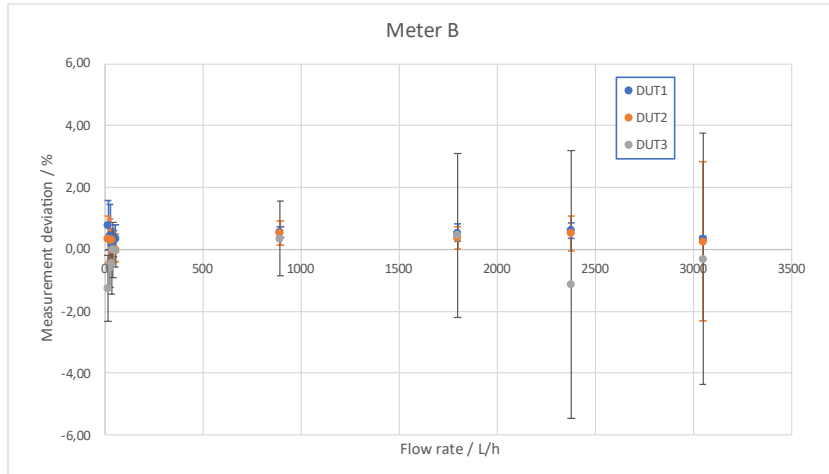

Dynamic performance

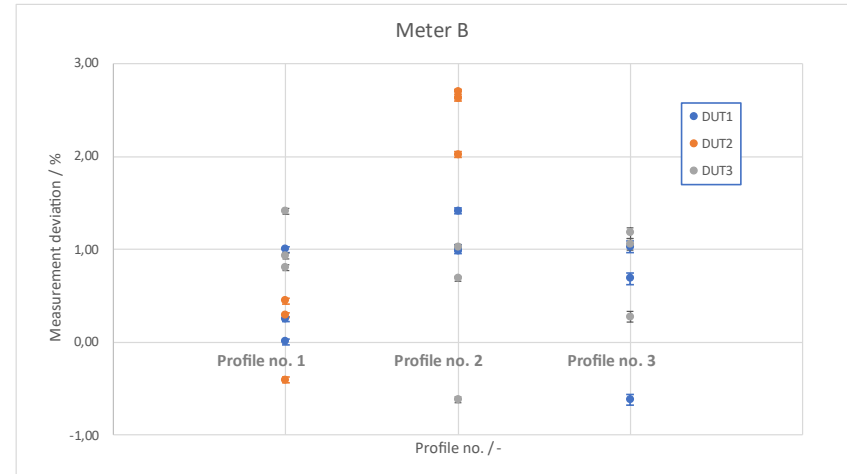

Meter B: Magnetic inductive water meter DN 15, Q3 2.5 R800



Measurement results (CMI)

CMI (Czech metrology institute)

- Number of meter types: 4 (Meter A – D)
- Quantity per meter type: 3 (= 12 pcs total)
- 3 dynamic profiles each
- Pulse output, flying start-and-stop



Static performance

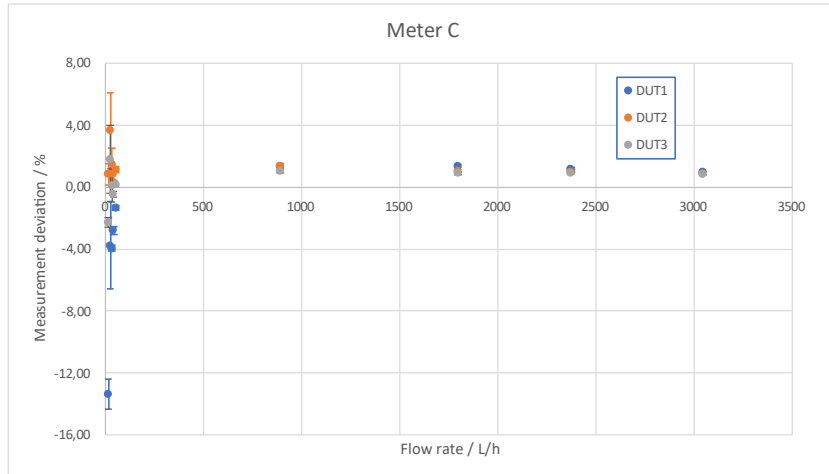

Dynamic performance

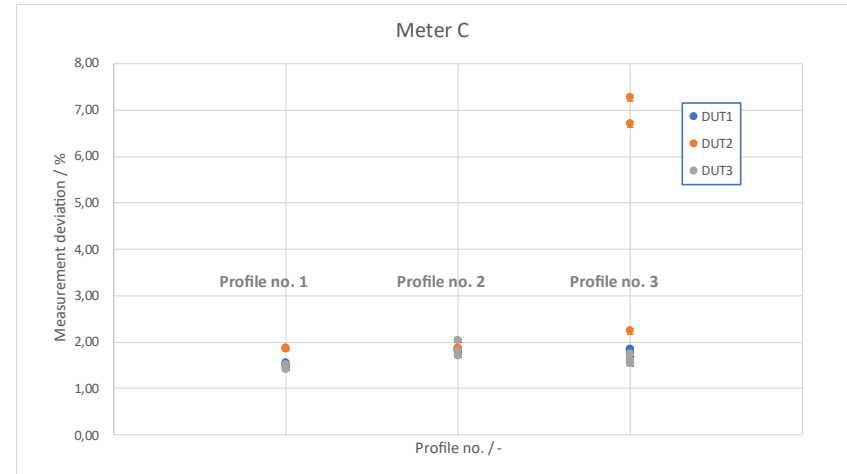

Meter C: Multi-jet water meter DN 15, Q3 2.5 R160



Measurement results (CMI)

CMI (Czech metrology institute)

- Number of meter types: 4 (Meter A – D)
- Quantity per meter type: 3 (= 12 pcs total)
- 3 dynamic profiles each
- Pulse output, flying start-and-stop



Static performance

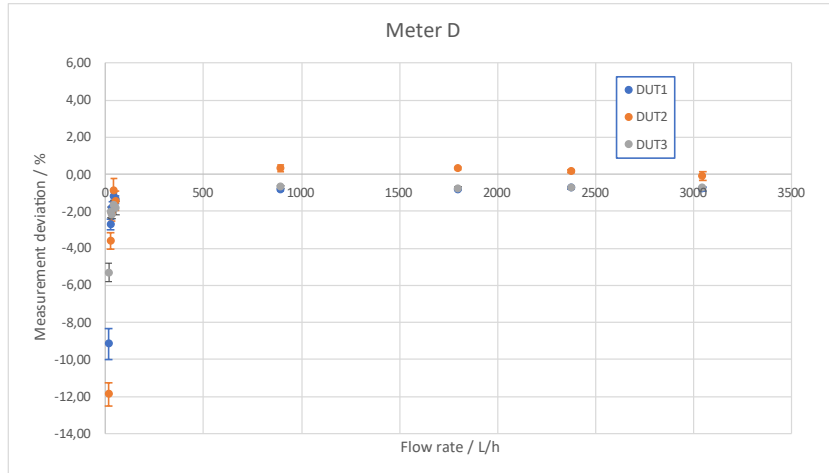

Dynamic performance

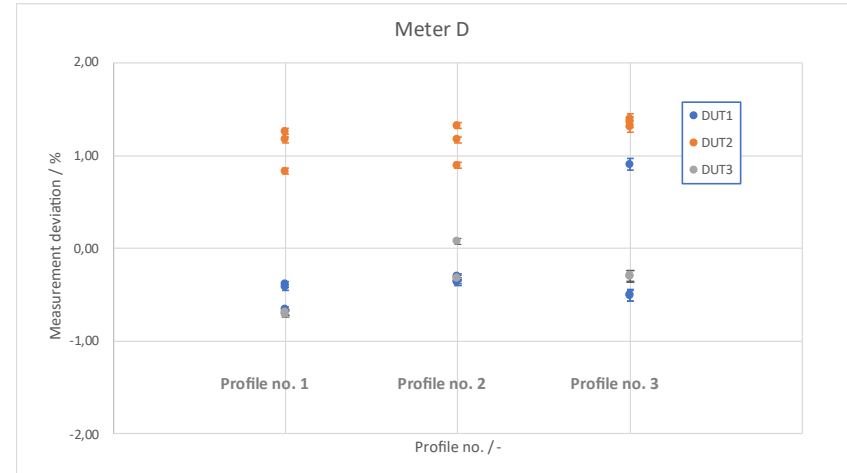

Meter D: Single-jet water meter DN 15, Q3 1.5 R80



Measurement results (PTB)

PTB (Physikalisch-Technische Bundesanstalt)

Number of meter types: 3 (Meter A – C)

Quantity per meter type: 1 (= 3 pcs total)

3 dynamic profiles each

Pulse output, flying start-and-stop

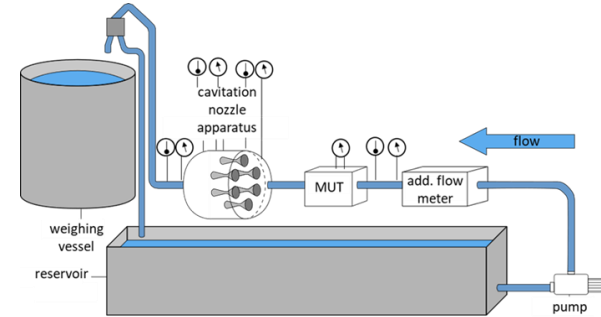

Static performance

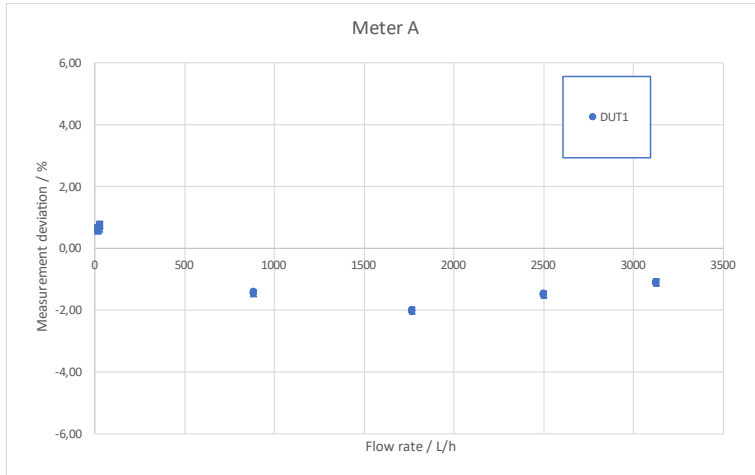

Dynamic performance



Meter A: Multi-jet water meter DN 20, Q3 2.5 R160



Measurement results (PTB)

PTB (Physikalisch-Technische Bundesanstalt)

Number of meter types: 3 (Meter A – C)

Quantity per meter type: 1 (= 3 pcs total)

3 dynamic profiles each

Pulse output, flying start-and-stop

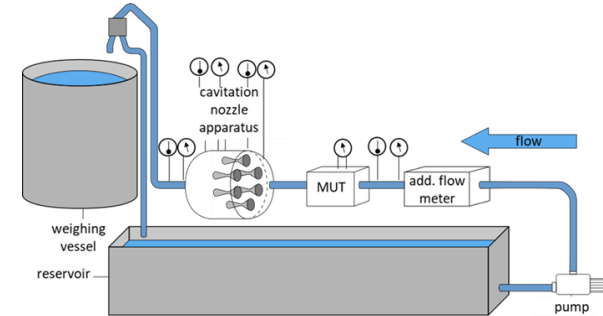

Static performance

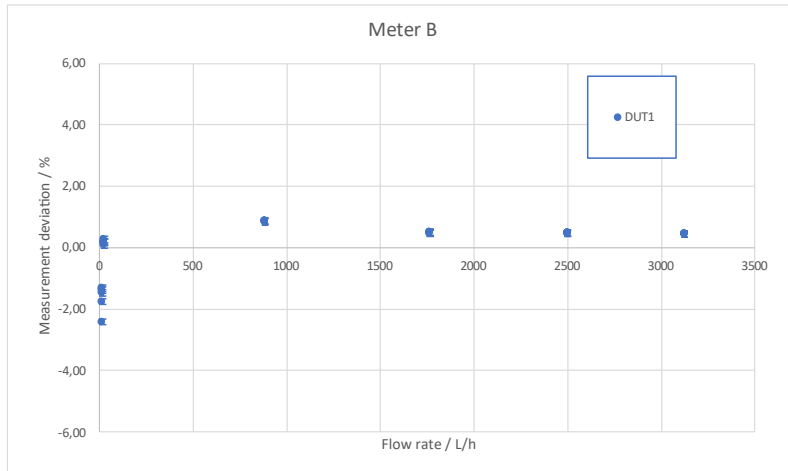

Dynamic performance



Meter B: Piston water meter DN 15, Q3 2.5 R160



Measurement results (PTB)

PTB (Physikalisch-Technische Bundesanstalt)

Number of meter types: 3 (Meter A – C)

Quantity per meter type: 1 (= 3 pcs total)

3 dynamic profiles each

Pulse output, flying start-and-stop

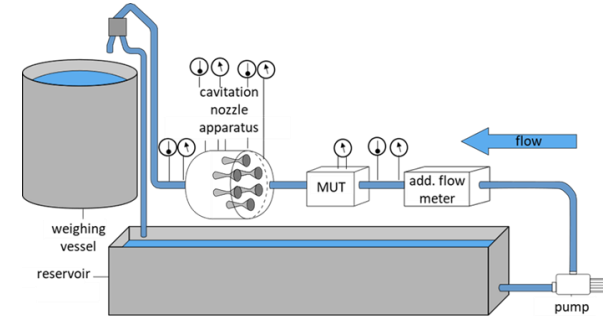

Static performance

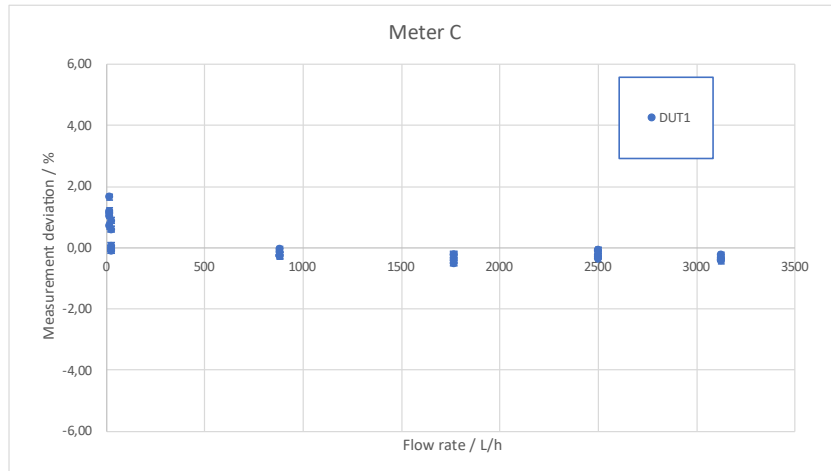

Dynamic performance

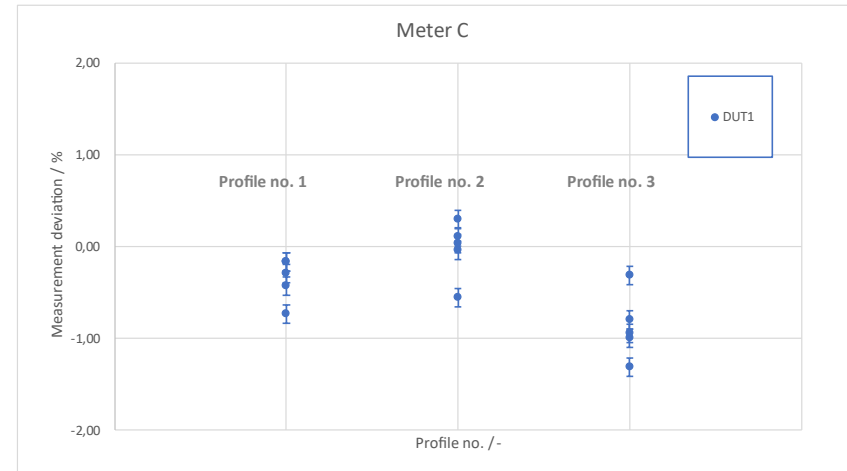

Meter C: US water meter DN 20, Q3 2.5 R400



Measurement results (DTI)

DTI (Danish Technological Institute)

Number of meter types: 3 (Meter A – C)

Quantity per meter type: 2 (= 6 pcs total)

3 dynamic profiles each

Pulse output (flying start-and-stop) & display reading (standing start-and-stop)



Static performance

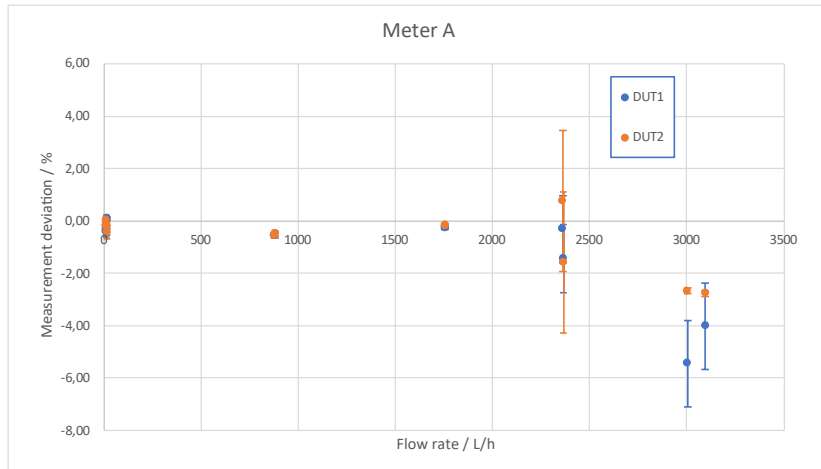

Dynamic performance

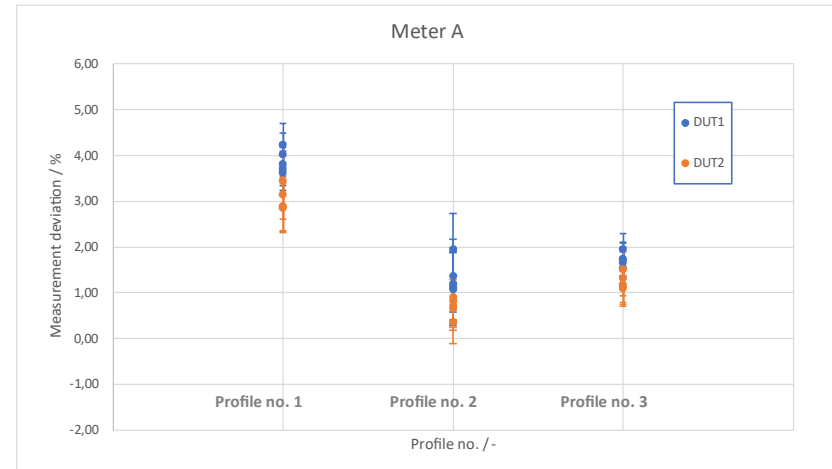

Meter A: US water meter DN 20, Q3 2.5 R250 (pulse output)



Measurement results (DTI)

DTI (Danish Technological Institute)

Number of meter types: 3 (Meter A – C)

Quantity per meter type: 2 (= 6 pcs total)

3 dynamic profiles each

Pulse output (flying start-and-stop) & display reading (standing start-and-stop)



Static performance

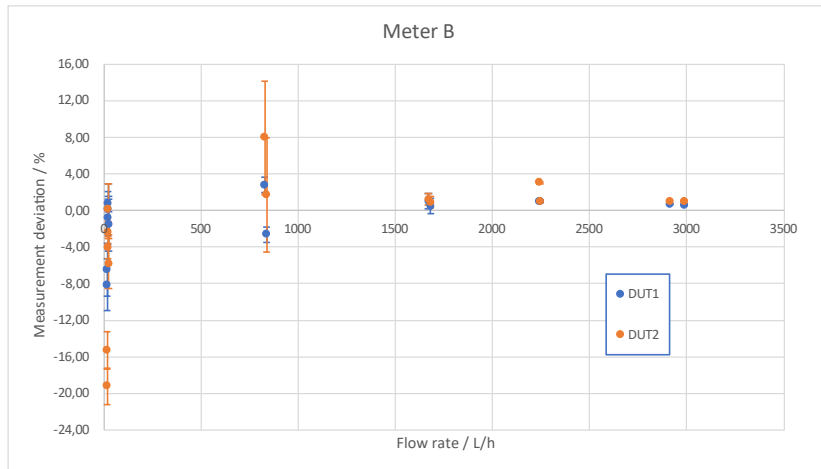

Dynamic performance

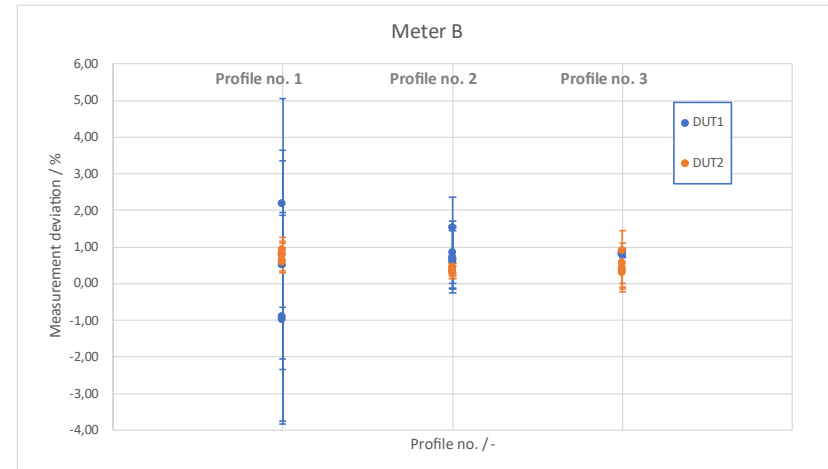

Meter B: Multi-jet water meter DN 20, Q3 2.5 R160 (display reading)



Measurement results (DTI)

DTI (Danish Technological Institute)

Number of meter types: 3 (Meter A – C)

Quantity per meter type: 2 (= 6 pcs total)

3 dynamic profiles each

Pulse output (flying start-and-stop) & display reading (standing start-and-stop)



Static performance

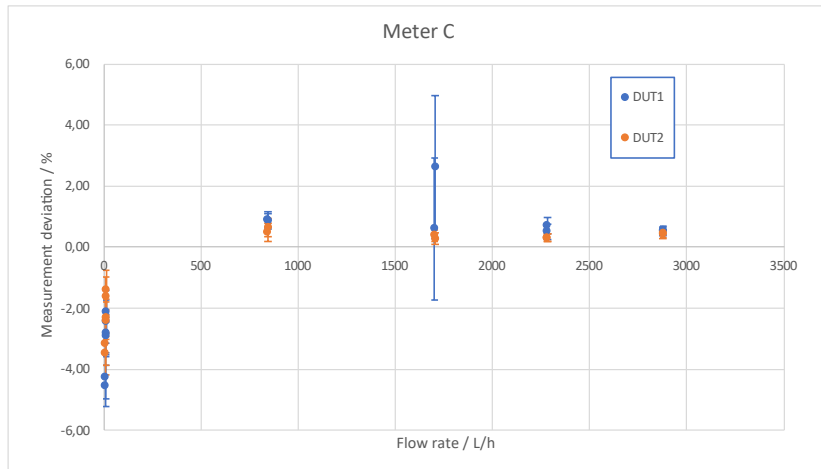

Dynamic performance

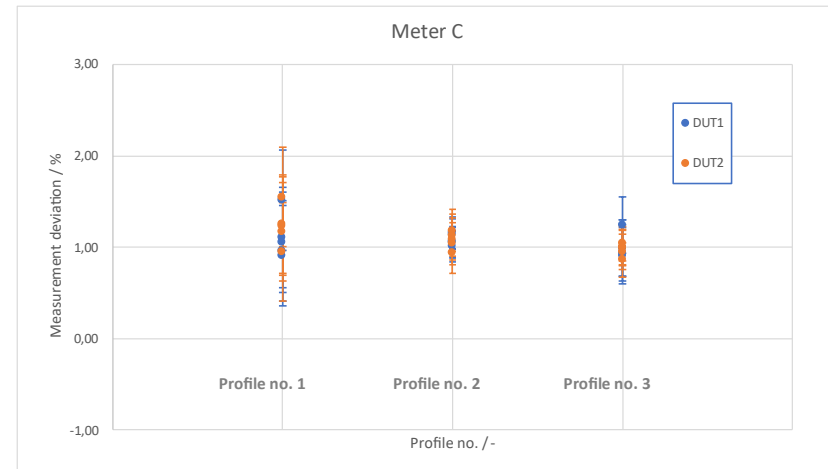



Measurement results (VTT)

VTT (Technical Research Centre of Finland)

Number of meter types: 1 (Meter A)

Quantity per meter type: 1 (= 1 pcs total)

3 dynamic profiles

Display reading (standing start-and-stop)

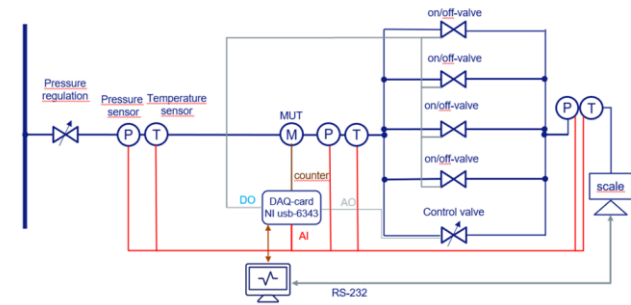

Static performance

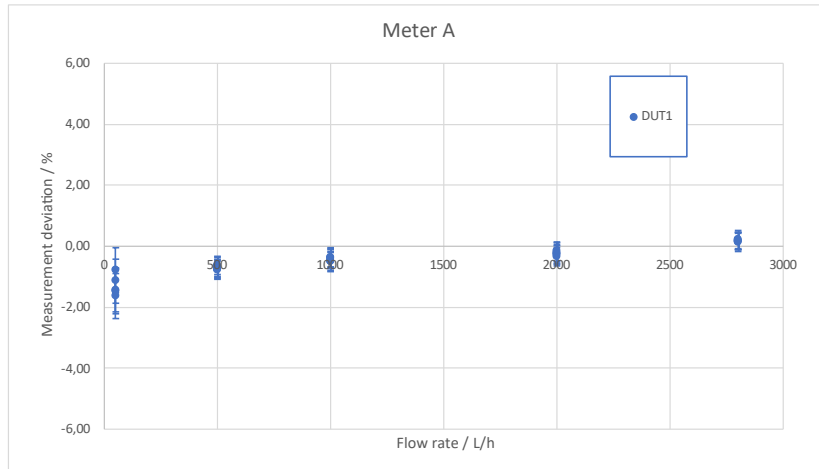

Dynamic performance

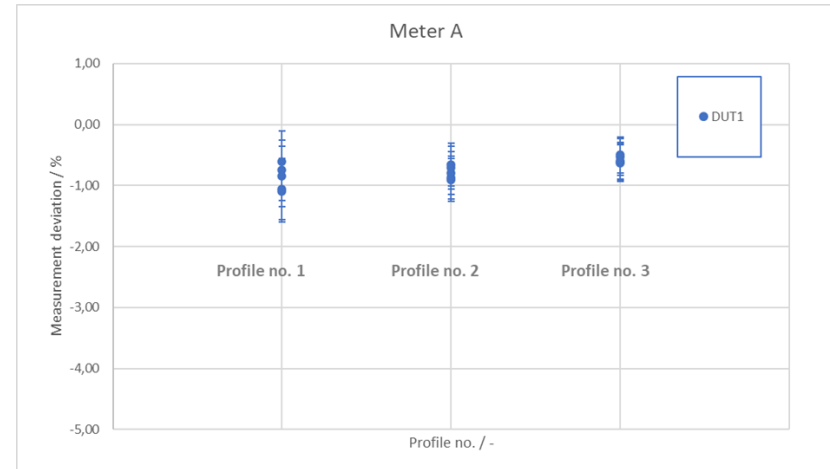

Meter C: Ultrasonic water meter DN 20, Q3 2.5 R160



Measurement results (TÜBİTAK)

TÜBİTAK (Scientific and Technological Research Council of Turkey)

Number of meter types: 2 (Meter A – B)

Quantity per meter type: 1 (= 2 pcs total)

1 dynamic profile each

Display reading (standing start-and-stop)



TÜBİTAK

Static performance

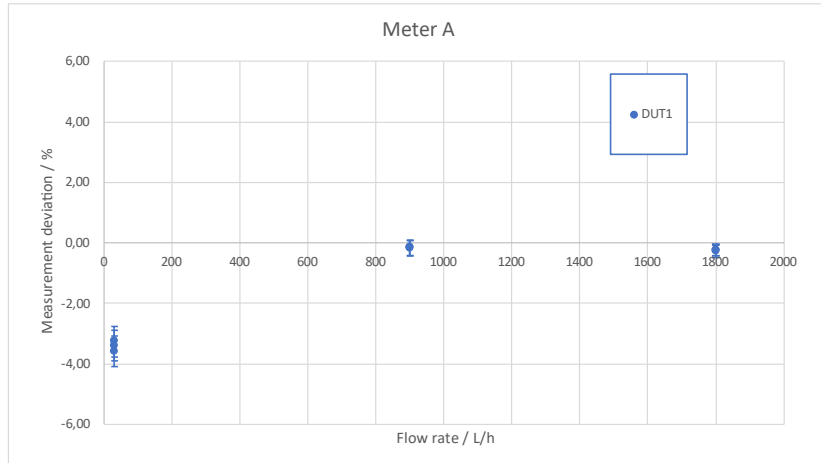

Dynamic performance

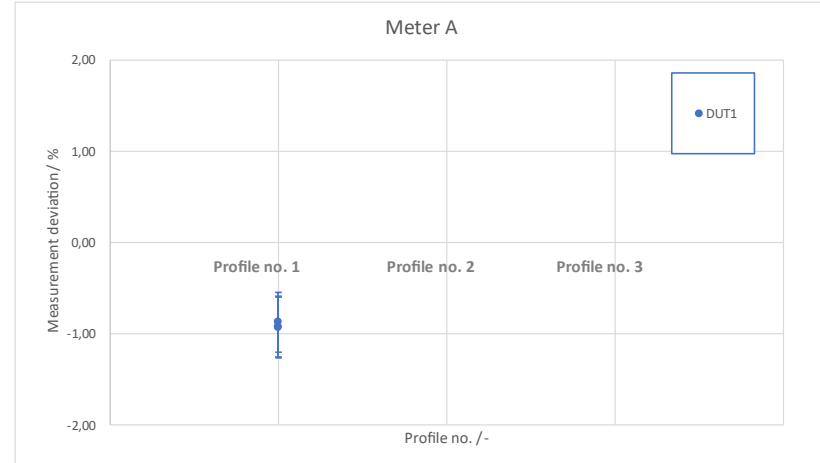

Meter A: Ultrasonic water meter DN 20, Q3 2.5 R250



Measurement results (TÜBİTAK)

TÜBİTAK (Scientific and Technological Research Council of Turkey)

Number of meter types: 2 (Meter A – B)

Quantity per meter type: 1 (= 2 pcs total)

1 dynamic profile each

Display reading (standing start-and-stop)



TÜBİTAK

Static performance

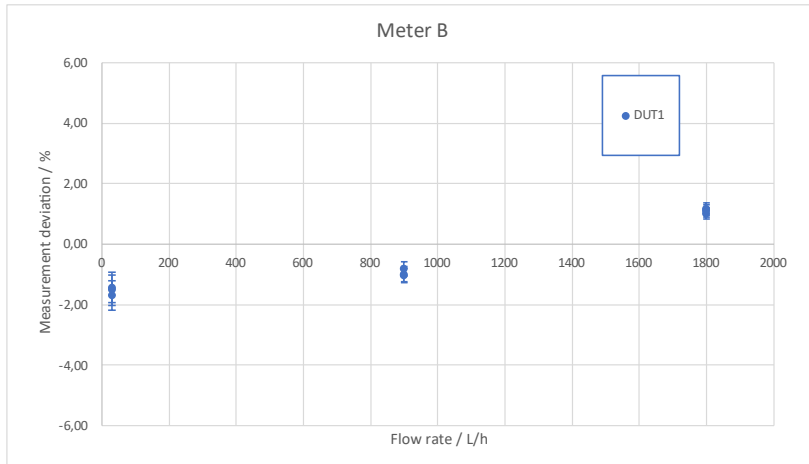

Dynamic performance

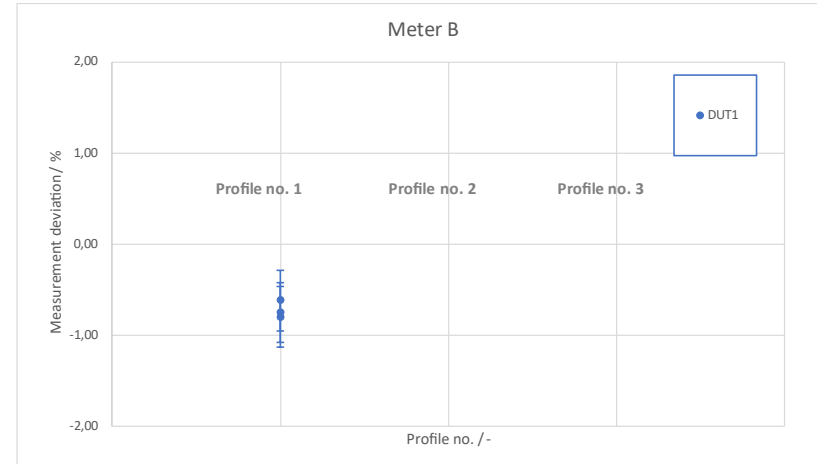

Meter B: Multi-jet water meter DN 20, Q3 2.5 R160



Measurement results (FORCE)

FORCE Technology (Denmark)



Number of meter types: 3 (Meter A – C)
 Quantity per meter type: 3 (= 9 pcs total)
 1 dynamic profile each
 Display reading (standing start-and-stop)

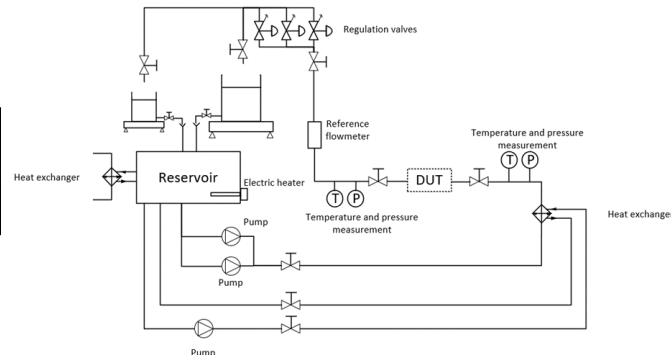

Static performance

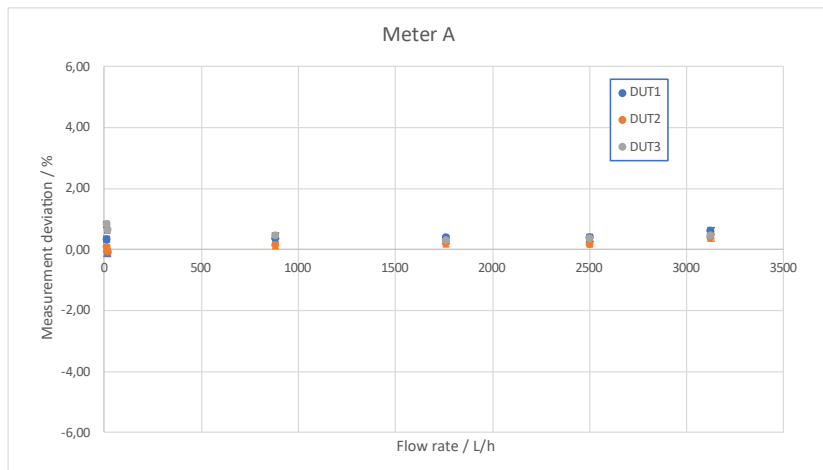

Dynamic performance

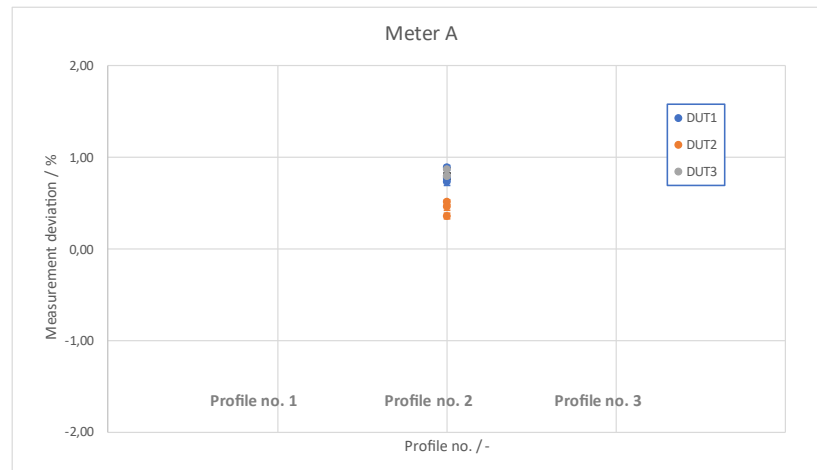

Meter A: Ultrasonic water meter DN 20, Q3 2.5 R250 (pulse output)



Measurement results (FORCE)

FORCE Technology (Denmark)



Number of meter types: 3 (Meter A – C)
 Quantity per meter type: 3 (= 9 pcs total)
 1 dynamic profile each
 Display reading (standing start-and-stop)

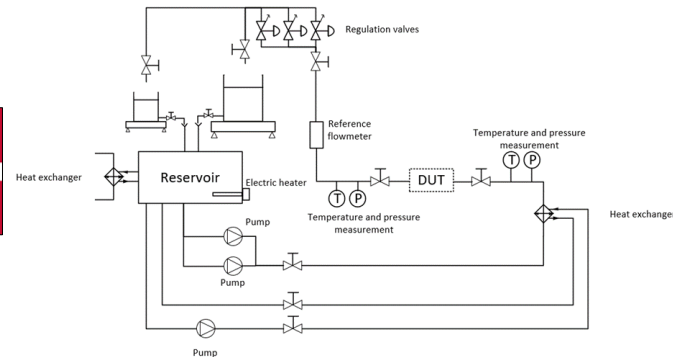

Static performance

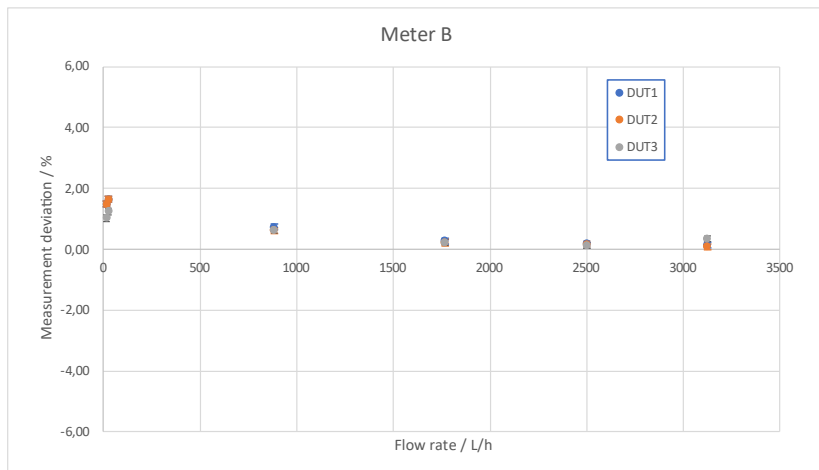

Dynamic performance

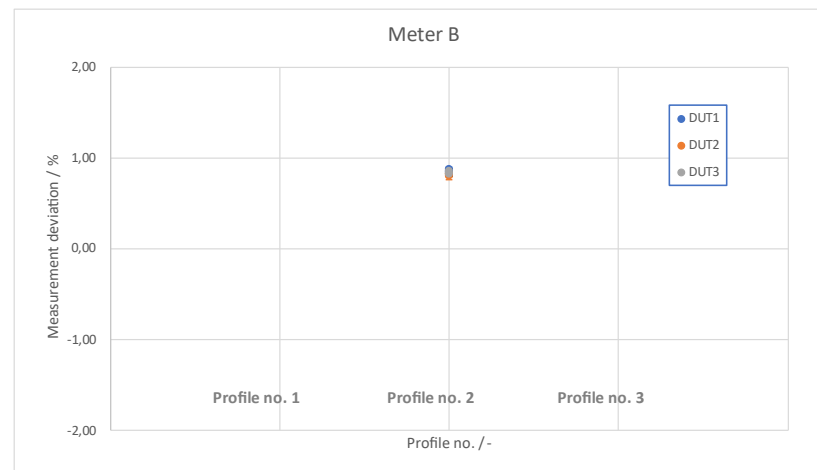

Meter B: Multi-jet water meter DN 20, Q3 2.5 R160



Measurement results (FORCE)

FORCE Technology (Denmark)



Number of meter types: 3 (Meter A – C)
 Quantity per meter type: 3 (= 9 pcs total)
 1 dynamic profile each
 Display reading (standing start-and-stop)

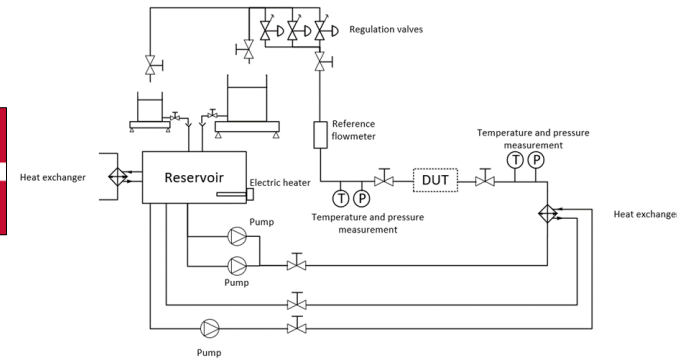

Static performance

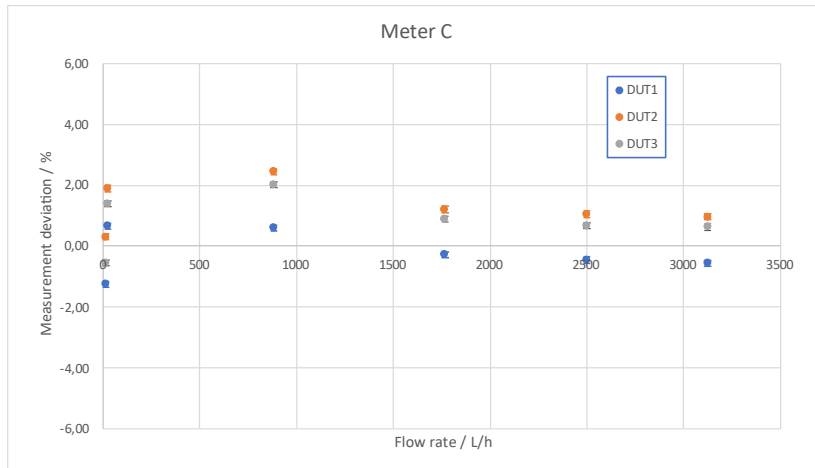

Dynamic performance

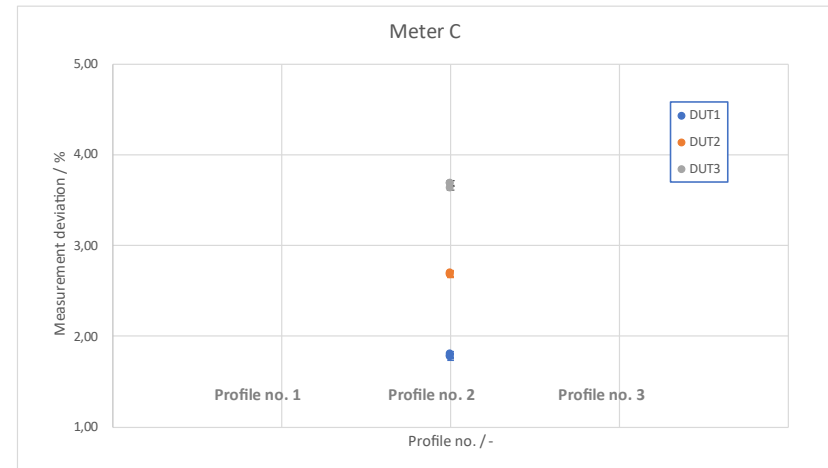

Meter C: Piston water meter DN 20, Q3 2.5 R160



Measurement results (RISE)

RISE (Research Institutes of Sweden)

Number of meter types: 2 (Meter A – B)

Quantity per meter type: 3 (= 6 pcs total)

3 dynamic profiles each

Pulse output, flying start-and-stop



Static performance

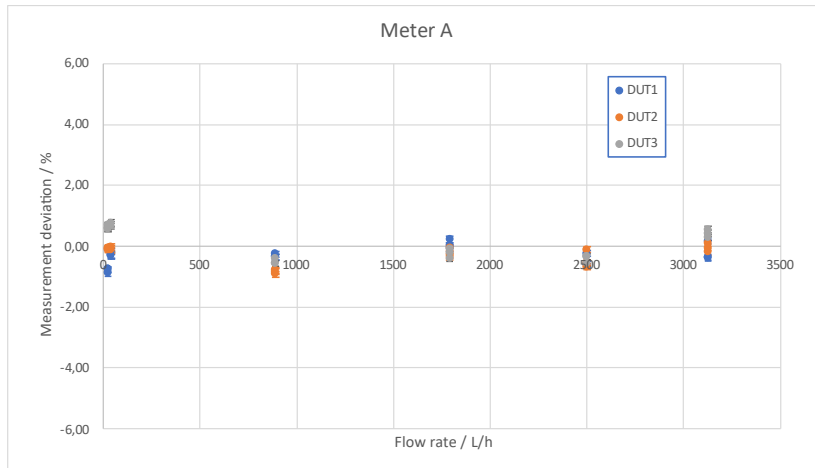

Dynamic performance

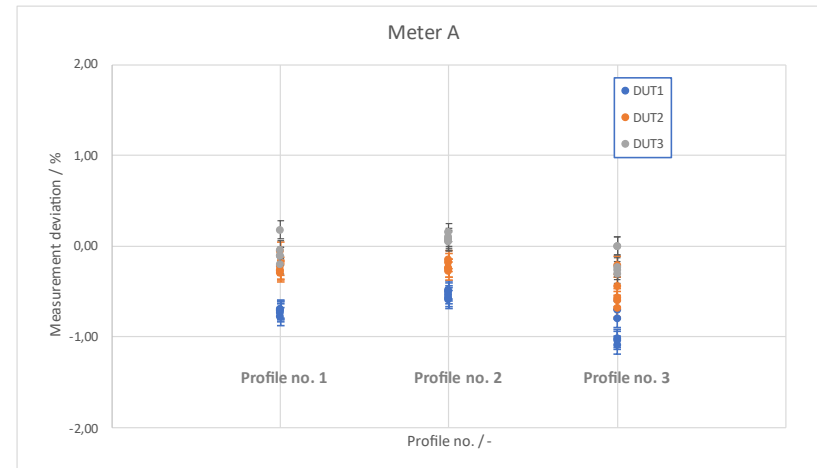

Meter A: Ultrasonic water meter DN 20, Q3 2.5 R100



Measurement results (RISE)

RISE (Research Institutes of Sweden)

Number of meter types: 2 (Meter A – B)

Quantity per meter type: 3 (= 6 pcs total)

3 dynamic profiles each

Pulse output, flying start-and-stop



Static performance

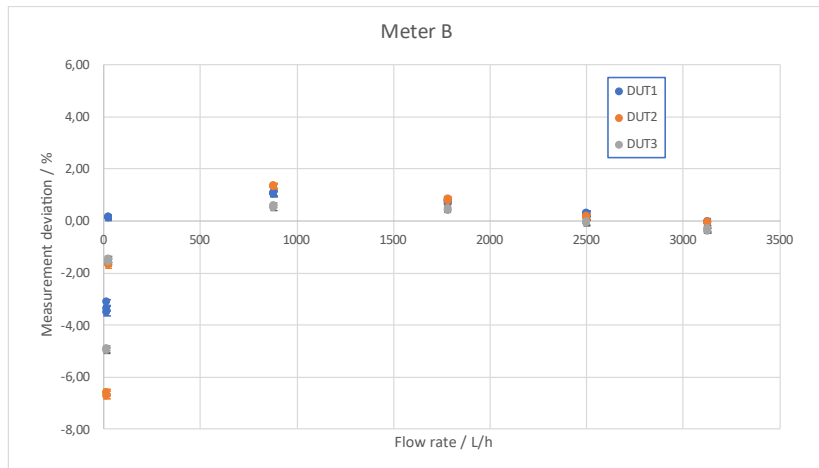

Dynamic performance

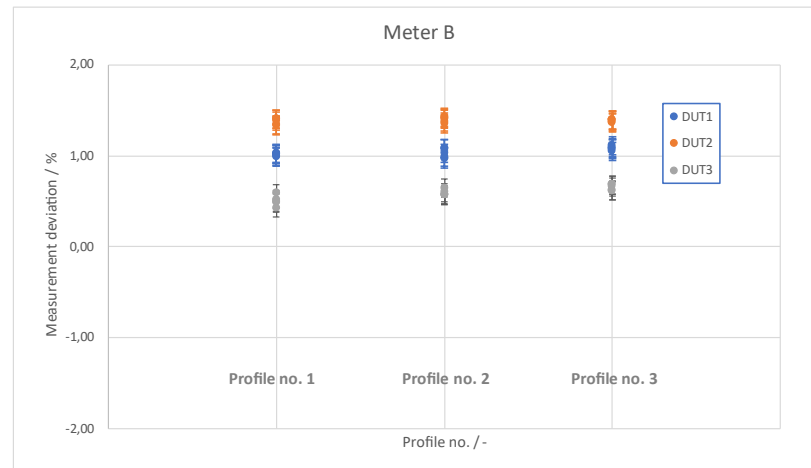

Meter A: Multi-jet meter DN 20, Q3 2.5 R160



Summary

Water meters Q3 2.5	Ultrasonic	Multi-jet	Piston	MAG	Single-jet
Number (quantity):	11	13	9	3	3
Size DN15:	0	3	4	3	3
DN20:	11	10	5	0	0
R-values	R100: 3 R250: 7 R400: 1	R160: 10	R160: 6 R400: 3	R800: 3	R80: 3
Pulse output (flying):	6	7	4	3	3
Display (standing):	5	6	5	0	0
Failed static calibration:	2	5	2	1	3
Failed dynamic calibration					
MPE 2 % :	P1: 2	P1: 2; P3: 1	P2: 2	P2: 1	0
MPE 5 % :	P1: 0	P1: 0; P3: 1	P2: 0	P2: 0	

In total: 39 water meters (13 x DN15 and 26 x DN20):

13 failed static calibration, 4 failed P1(2%), 3 failed P2(2%) and 1 failed P3(2%,5%).



Acknowledgment

This project 17IND13 has received funding from the EMPIR programme co-financed by the Participating States and from the European Union's Horizon 2020 research and innovation programme



Thank you for your attention!

Oliver Büker

oliver.buker@ri.se
+46-10 516 5889



<https://www.ptb.de/empir2018/metrowamet/the-project/>